



**Alüminyum Profil** Katalođu  
Aluminum Profile Catalogue

# **BILGE**

PERGOLA & OUTDOOR LIVING SYSTEMS





■ **BİLGE PERGOLA STANDART PROFİLLER / BILGE PERGOLA STANDART PROFILES**

<b>Dikey Profiller / Vertical Curtain System</b>	<b>9</b>
<b>Aldoks Kapı ve Pencere Profilleri / Aldoks Door and Window Profiles</b>	<b>10 - 11</b>
<b>C60 Kapı ve Pencere Profilleri / C60 Door and Window Profiles</b>	<b>12 - 13</b>
<b>Doğrama Profilleri / Joinery Profiles</b>	<b>14 - 21</b>
<b>Boru Profilleri / Tube Profiles</b>	<b>22 - 27</b>
<b>Menteşe Profilleri / Hinge Profiles</b>	<b>28 - 31</b>
<b>Kulp Profilleri / Handle Profiles</b>	<b>32 - 35</b>
<b>Sineklik Profilleri / Mosquito Net Profiles</b>	<b>36 - 37</b>
<b>Aydınlatma Profilleri / Lighting Profiles</b>	<b>38 - 47</b>
<b>Soğutma Profilleri / Cooling Profiles</b>	<b>48 - 49</b>
<b>Küpeşte Profilleri / Handrail Profiles</b>	<b>50 - 51</b>
<b>Menfez Profilleri / Air Went Profiles</b>	<b>52 - 53</b>
<b>Cephe Profilleri / Facade Profiles</b>	<b>54 - 57</b>
<b>Solar Profiller / Solar Profiles</b>	<b>58 - 61</b>
<b>Kepenk ve Panjur Profilleri / Shutter Profiles</b>	<b>62 - 71</b>
<b>Fotoselli Kapı Profilleri / Photocell Door Profiles</b>	<b>72 - 73</b>

■ **TENTE PROFİLLERİ / AWNING PROFILES**

<b>Kasetli Tente Profilleri / Cassette Awning Profiles</b>	<b>75 - 77</b>
<b>Pencere Kasetli Tente Profilleri / Window Cassette Awning Profiles</b>	<b>78 - 79</b>
<b>Mafsallı Tente Profilleri / Articulated Awning Profiles</b>	<b>80 - 83</b>

**■ PERGOLA SİSTEMLERİ / PERGOLA SYSTEMS**

**Hitit Egimli ve Oval Pergola Sistemleri / Hittite Inclined and Curved Pergola Systems** **86 - 93**

**■ BİOKLİMATİK SİSTEMLERİ / BIOCLIMATIC SYSTEMS**

**Sümer Bioklimatik / Sumer Bioclimatic** **94 - 97**

**Frigya Bioklimatik / Phrygia Bioclimatic** **98 - 101**

**Lidya Bioklimatik / Lydia Bioclimatic** **102 - 105**

**Cabana Bioklimatik / Cabana Bioclimatic** **106 - 107**

**■ ROLLING ROOF SİSTEMLERİ / ROOLING ROOF SYSTEMS**

**Luvi Rolling Roof Profilleri / Luvian Rolling Roof Systems** **108 - 111**

**■ HAREKETLİ VE SABİT CAM TAVAN SİSTEMLERİ / MOVABLE AND FIXED GLASS ROOF SYSTEMS**

**İyonya Veranda Sistemleri / Ionian Veranda Systems** **112 - 117**

**Pergamon Sürgülü Cam Çatı Sistemleri / Pergamon Movable Glass Roof Systems** **118 - 121**

**Karya Küp Veranda Sistemleri / Carians Cube Veranda Systems** **122 - 125**

**■ CAM SİSTEMLERİ / GLASS SYSTEMS**

**Modena Sürme Sistemleri / Modena Sliding Systems** **126 - 129**

**Giyotin Cam Sistemleri / Guillotine Glass Systems** **130 - 133**

**Isı Camlı Sürme Sistemleri / Double Glass Sliding Systems** **134 - 137**

**Katlanır Cam Sistemleri / Folding Glass Systems** **138 - 141**

**Selçuklu Çift Sürme Sistemleri / Seljuk Double Glass Sliding Systems** **142 - 145**

**Urartu Çift Sürme Sistemleri / Urartu Double Glass Sliding Systems** **146 - 149**

**Hazar Giyotin Cam Sistemleri / Hazar Guillotine Glass Systems** **150 - 153**

**■ ZİP PERDE SİSTEMLERİ / ZIP CURTAIN SYSTEMS**

**Dikey Perde Sistemleri / Vertical Curtain Systems** **154 - 155**

**Yatay Perde Sistemleri / Horizontal Curtain Systems** **156 - 157**

**■ BAHÇE ÇİTİ VE RÜZGAR KIRICI SİSTEMLERİ / GARDEN FENCE AND WINDBRAKER SYSTEMS**

**Bahçe Çiti Sistemleri / Garden Fence Systems** **158 - 163**

**Rüzgar Kırıcı Sistemleri / Windbraker Systems** **164 - 165**



We produce **high quality outdoor living systems** with superior technology





PERGOLA & OUTDOOR LIVING SYSTEMS

**BİLGE PERGOLA  
STANDART PROFİLLER**  
STANDART PROFILES



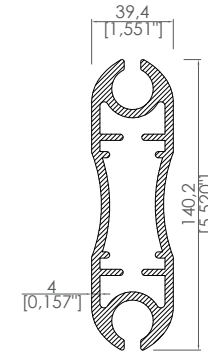
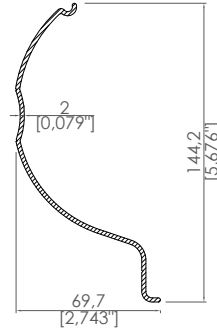
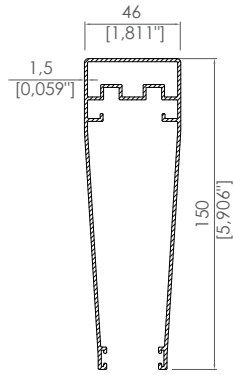

Ürün Kodu / Product Code	5311
Kalınlık / Thickness	1,5 mm
Ağırlık / Weight	1,793 kg/m 3,953 lb/m

Ürün Kodu / Product Code	6336
Kalınlık / Thickness	2 mm
Ağırlık / Weight	1,051 kg/m 2,317 lb/m

Ürün Kodu / Product Code	6335
Kalınlık / Thickness	4 mm
Ağırlık / Weight	1,225 kg/m 2,7007 lb/m

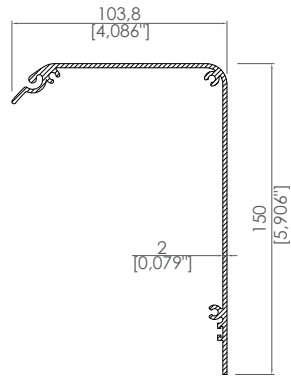

Ürün Kodu / Product Code	6337
Kalınlık / Thickness	2 mm
Ağırlık / Weight	1,691 kg/m 3,728 lb/m



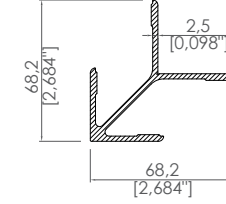

Ürün Kodu / Product Code	2239
Kalınlık / Thickness	2,5 mm
Ağırlık / Weight	1,327 kg/m 2,9255 lb/m

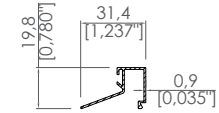
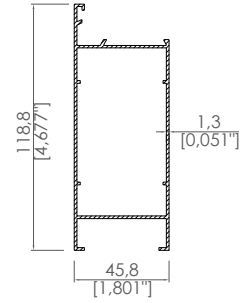
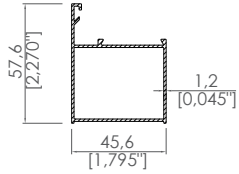

Ürün Kodu / Product Code	2235
Kalınlık / Thickness	1,2 mm
Ağırlık / Weight	0,626 kg/m 1,38 lb/m

Ürün Kodu / Product Code	2238
Kalınlık / Thickness	1,3 mm
Ağırlık / Weight	1,156 kg/m 2,5485 lb/m

Ürün Kodu / Product Code	2241
Kalınlık / Thickness	0,9 mm
Ağırlık / Weight	0,185 kg/m 0,40786 lb/m

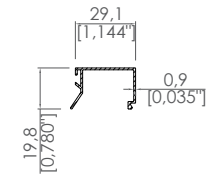
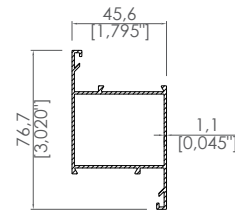
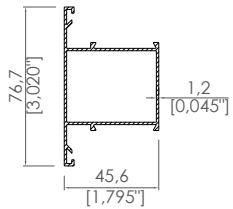

Ürün Kodu / Product Code	2236
Kalınlık / Thickness	1,2 mm
Ağırlık / Weight	0,741 kg/m 1,6336 lb/m

Ürün Kodu / Product Code	2237
Kalınlık / Thickness	1,1 mm
Ağırlık / Weight	0,741 kg/m 1,6336 lb/m

Ürün Kodu / Product Code	2240
Kalınlık / Thickness	0,9 mm
Ağırlık / Weight	0,192 kg/m 0,4233 lb/m

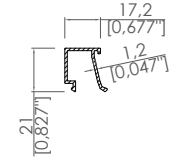

Ürün Kodu / Product Code	2226
Kalınlık / Thickness	1,2 mm
Ağırlık / Weight	0,211 kg/m 0,4652 lb/m

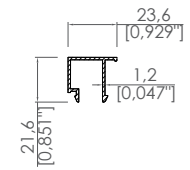

Ürün Kodu / Product Code	2227
Kalınlık / Thickness	1,2 mm
Ağırlık / Weight	0,237 kg/m 0,5225 lb/m

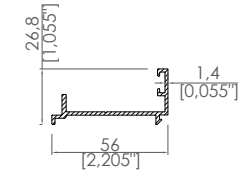
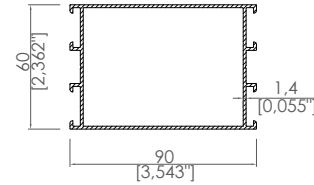
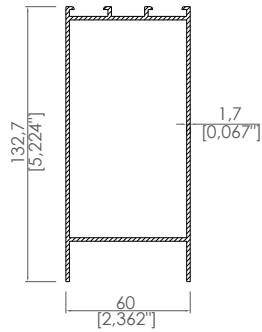

Ürün Kodu / Product Code	2220
Kalınlık / Thickness	1,7 mm
Ağırlık / Weight	1,818kg/m 4,008 lb/m

Ürün Kodu / Product Code	2222
Kalınlık / Thickness	1,4 mm
Ağırlık / Weight	1,265 kg/m 2,789 lb/m

Ürün Kodu / Product Code	2224
Kalınlık / Thickness	1,4 mm
Ağırlık / Weight	0,445 kg/m 0,981 lb/m

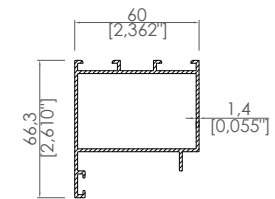
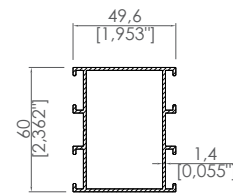
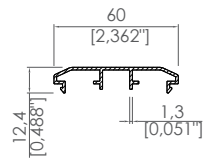

Ürün Kodu / Product Code	2225
Kalınlık / Thickness	1,3 mm
Ağırlık / Weight	0,394 kg/m 0,8686 lb/m

Ürün Kodu / Product Code	2221
Kalınlık / Thickness	1,4 mm
Ağırlık / Weight	0,963 kg/m 2,123 lb/m

Ürün Kodu / Product Code	2223
Kalınlık / Thickness	1,4 mm
Ağırlık / Weight	1,002 kg/m 2,209 lb/m

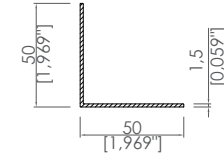
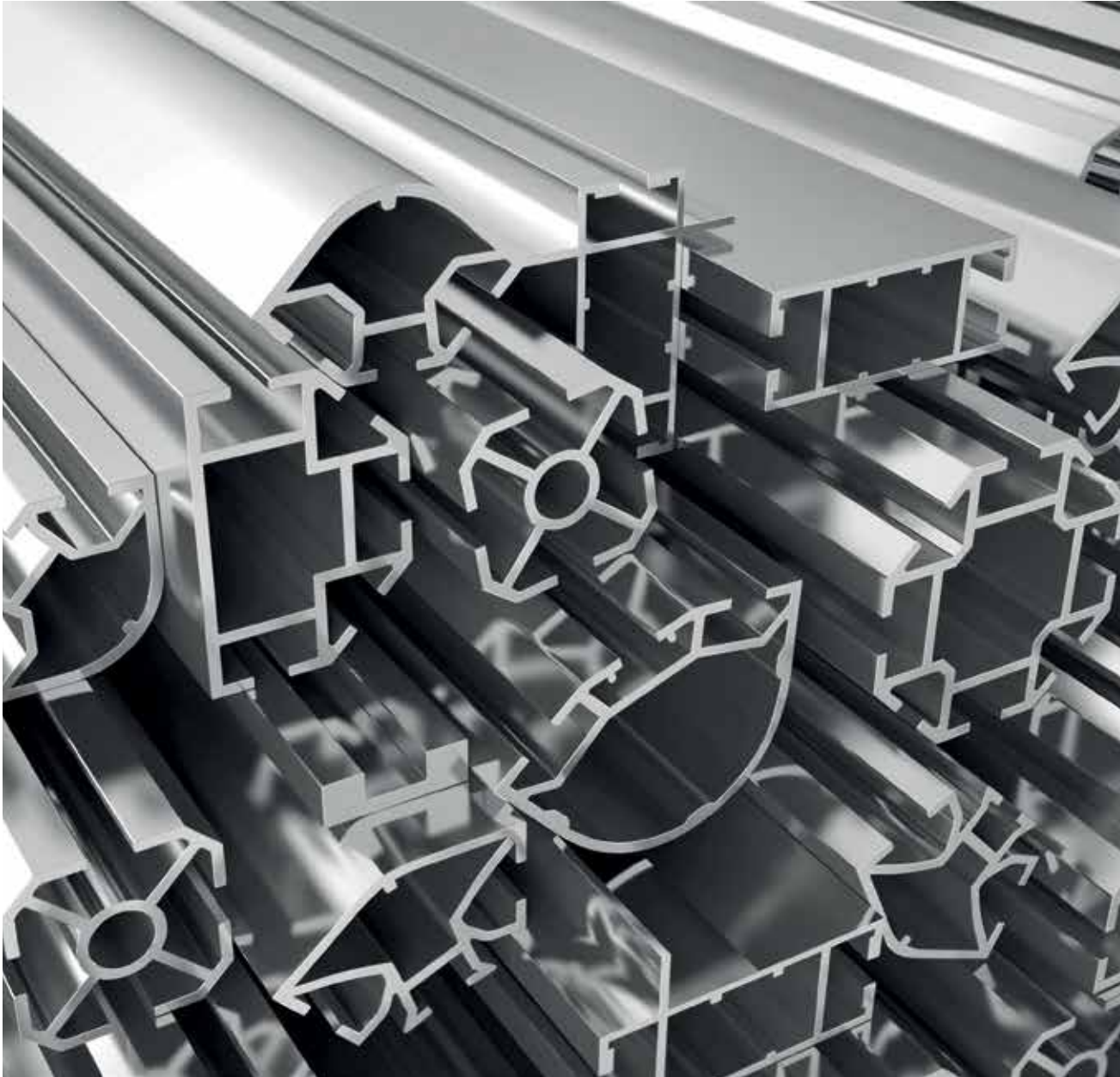

Ürün Kodu / Product Code	10043
Kalınlık / Thickness	1,5 mm
Ağırlık / Weight	0,402 kg/m 0,8863 lb/m

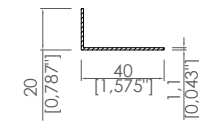

Ürün Kodu / Product Code	2394
Kalınlık / Thickness	1,1 mm
Ağırlık / Weight	0,177 kg/m 0,3902 lb/m

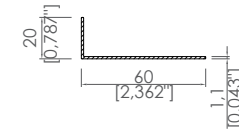
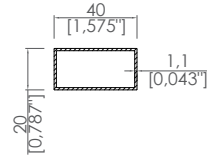
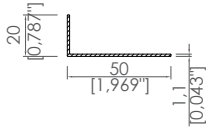

Ürün Kodu / Product Code	2395
Kalınlık / Thickness	1,1 mm
Ağırlık / Weight	0,204 kg/m 0,4497 lb/m

Ürün Kodu / Product Code	2384
Kalınlık / Thickness	1,1 mm
Ağırlık / Weight	0,347 kg/m 0,765 lb/m

Ürün Kodu / Product Code	2396
Kalınlık / Thickness	1,1 mm
Ağırlık / Weight	0,236 kg/m 0,5203 lb/m

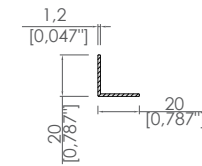
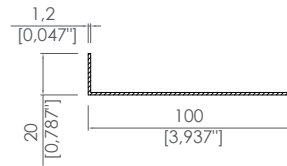
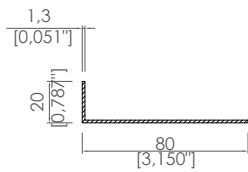

Ürün Kodu / Product Code	2397
Kalınlık / Thickness	1,3 mm
Ağırlık / Weight	0,350 kg/m 0,7716 lb/m

Ürün Kodu / Product Code	3460
Kalınlık / Thickness	1,2 mm
Ağırlık / Weight	0,388 kg/m 0,8554 lb/m

Ürün Kodu / Product Code	3458
Kalınlık / Thickness	1,2 mm
Ağırlık / Weight	0,125 kg/m 0,2756 lb/m

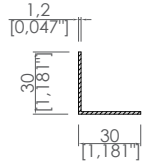

Ürün Kodu / Product Code	3459
Kalınlık / Thickness	1,2 mm
Ağırlık / Weight	0,192 kg/m 04233 lb/m

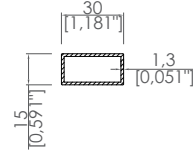

Ürün Kodu / Product Code	2002
Kalınlık / Thickness	1,3 mm
Ağırlık / Weight	0,299 kg/m 0,6592 lb/m

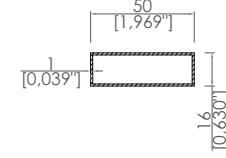

Ürün Kodu / Product Code	2609
Kalınlık / Thickness	1 mm
Ağırlık / Weight	0,350 kg/m 0,7716 lb/m

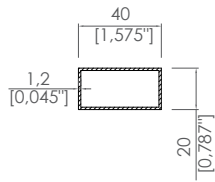

Ürün Kodu / Product Code	3594
Kalınlık / Thickness	1,2 mm
Ağırlık / Weight	0,412 kg/m 0,9083 lb/m

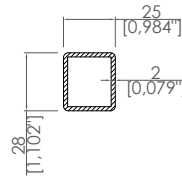

Ürün Kodu / Product Code	2974
Kalınlık / Thickness	2 mm
Ağırlık / Weight	0,518 kg/m 1,142 lb/m

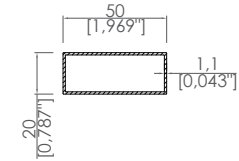

Ürün Kodu / Product Code	2386
Kalınlık / Thickness	1,1 mm
Ağırlık / Weight	0,407 kg/m 0,8973 lb/m

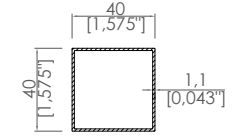
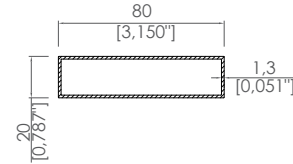
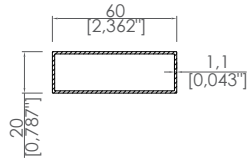

Ürün Kodu / Product Code	2387
Kalınlık / Thickness	1,1 mm
Ağırlık / Weight	0,467 kg/m 1,0296 lb/m

Ürün Kodu / Product Code	2391
Kalınlık / Thickness	1,3 mm
Ağırlık / Weight	0,689 kg/m 1,519 lb/m

Ürün Kodu / Product Code	2385
Kalınlık / Thickness	1,1 mm
Ağırlık / Weight	0,467 kg/m 1,0296 lb/m

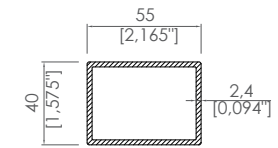
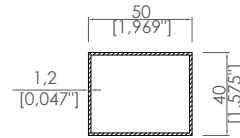
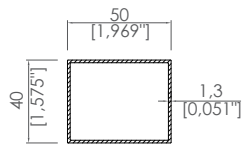

Ürün Kodu / Product Code	2388
Kalınlık / Thickness	1,3 mm
Ağırlık / Weight	0,618 kg/m 1,3625 lb/m

Ürün Kodu / Product Code	3453
Kalınlık / Thickness	1,2 mm
Ağırlık / Weight	0,569 kg/m 1,2544 lb/m

Ürün Kodu / Product Code	3634
Kalınlık / Thickness	2,4 mm
Ağırlık / Weight	1,170 kg/m 2,5794 lb/m

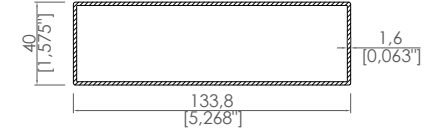
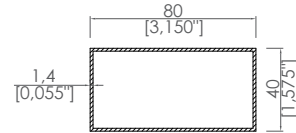
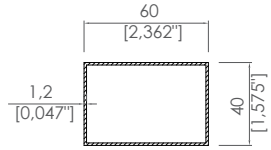

Ürün Kodu / Product Code	3454
Kalınlık / Thickness	1,2 mm
Ağırlık / Weight	0,569 kg/m 1,2544 lb/m

Ürün Kodu / Product Code	3456
Kalınlık / Thickness	1,4 mm
Ağırlık / Weight	0,889 kg/m 1,96 lb/m

Ürün Kodu / Product Code	37242
Kalınlık / Thickness	1,6 mm
Ağırlık / Weight	1,478 kg/m 3,2584 lb/m

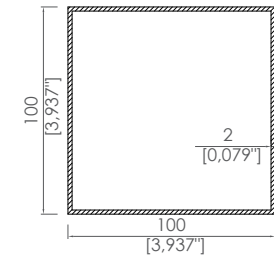
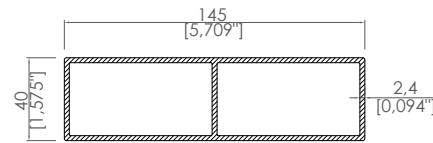
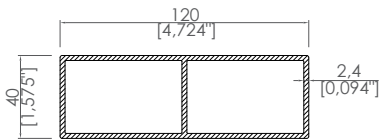

Ürün Kodu / Product Code	3637
Kalınlık / Thickness	2,4 mm
Ağırlık / Weight	2,247 kg/m 4,954 lb/m

Ürün Kodu / Product Code	3638
Kalınlık / Thickness	2,4 mm
Ağırlık / Weight	2,572 kg/m 5,67 lb/m

Ürün Kodu / Product Code	1520
Kalınlık / Thickness	2 mm
Ağırlık / Weight	2,125 kg/m 4,685 lb/m

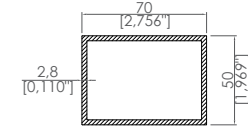
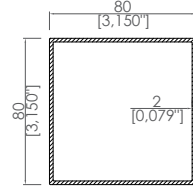
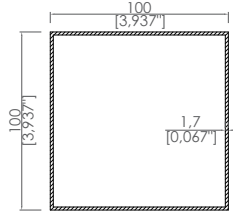

Ürün Kodu / Product Code	3366
Kalınlık / Thickness	1,7 mm
Ağırlık / Weight	1,810 kg/m 3,99 lb/m

Ürün Kodu / Product Code	2114
Kalınlık / Thickness	2 mm
Ağırlık / Weight	1,692 kg/m 3,73 lb/m

Ürün Kodu / Product Code	3305
Kalınlık / Thickness	2,8 mm
Ağırlık / Weight	1,737 kg/m 3,8294 lb/m

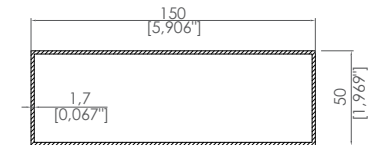
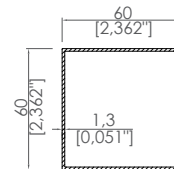
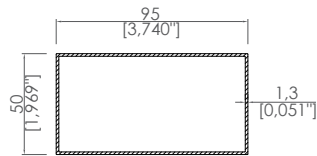

Ürün Kodu / Product Code	2389
Kalınlık / Thickness	1,3 mm
Ağırlık / Weight	1,006 kg/m 2,218 lb/m

Ürün Kodu / Product Code	2390
Kalınlık / Thickness	1,3 mm
Ağırlık / Weight	0,830 kg/m 1,83 lb/m

Ürün Kodu / Product Code	3365
Kalınlık / Thickness	1,7 mm
Ağırlık / Weight	1,810 kg/m 3,99 lb/m

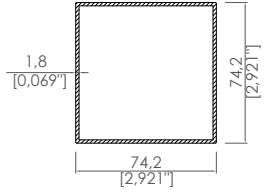

Ürün Kodu / Product Code	37186
Kalınlık / Thickness	1,8 mm
Ağırlık / Weight	1,374 kg/m 3,029 lb/m

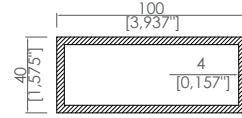

Ürün Kodu / Product Code	43002
Kalınlık / Thickness	4 mm
Ağırlık / Weight	2,861 kg/m 6,307 lb/m

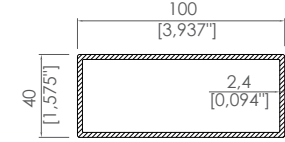

Ürün Kodu / Product Code	3636
Kalınlık / Thickness	2,4 mm
Ağırlık / Weight	1,756 kg/m 3,871 lb/m

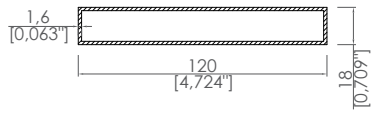

Ürün Kodu / Product Code	6351
Kalınlık / Thickness	1,6 mm
Ağırlık / Weight	1,168 kg/m 2,555 lb/m

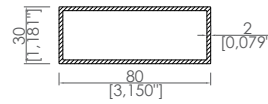

Ürün Kodu / Product Code	2919
Kalınlık / Thickness	2 mm
Ağırlık / Weight	1,150 kg/m 2,5353 lb/m

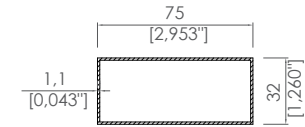

Ürün Kodu / Product Code	3455
Kalınlık / Thickness	1,1 mm
Ağırlık / Weight	0,626 kg/m 1,38 lb/m

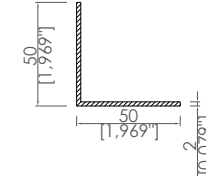
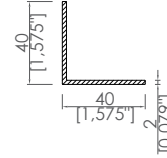
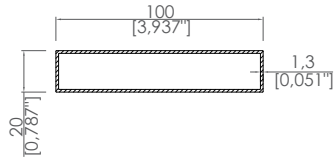

Ürün Kodu / Product Code	2392
Kalınlık / Thickness	1,3 mm
Ağırlık / Weight	0,830 kg/m 1,83 lb/m

Ürün Kodu / Product Code	10038
Kalınlık / Thickness	2 mm
Ağırlık / Weight	0,422 kg/m 0,9304 lb/m

Ürün Kodu / Product Code	10042
Kalınlık / Thickness	2 mm
Ağırlık / Weight	0,531 kg/m 1,1707 lb/m

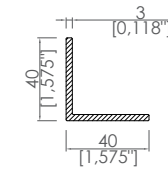
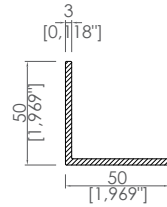
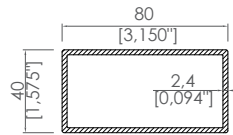

Ürün Kodu / Product Code	3635
Kalınlık / Thickness	2,4 mm
Ağırlık / Weight	1,496 kg/m 3,298 lb/m

Ürün Kodu / Product Code	3501
Kalınlık / Thickness	3 mm
Ağırlık / Weight	0,789 kg/m 1,7394 lb/m

Ürün Kodu / Product Code	3502
Kalınlık / Thickness	3 mm
Ağırlık / Weight	0,626 kg/m 1,38 lb/m

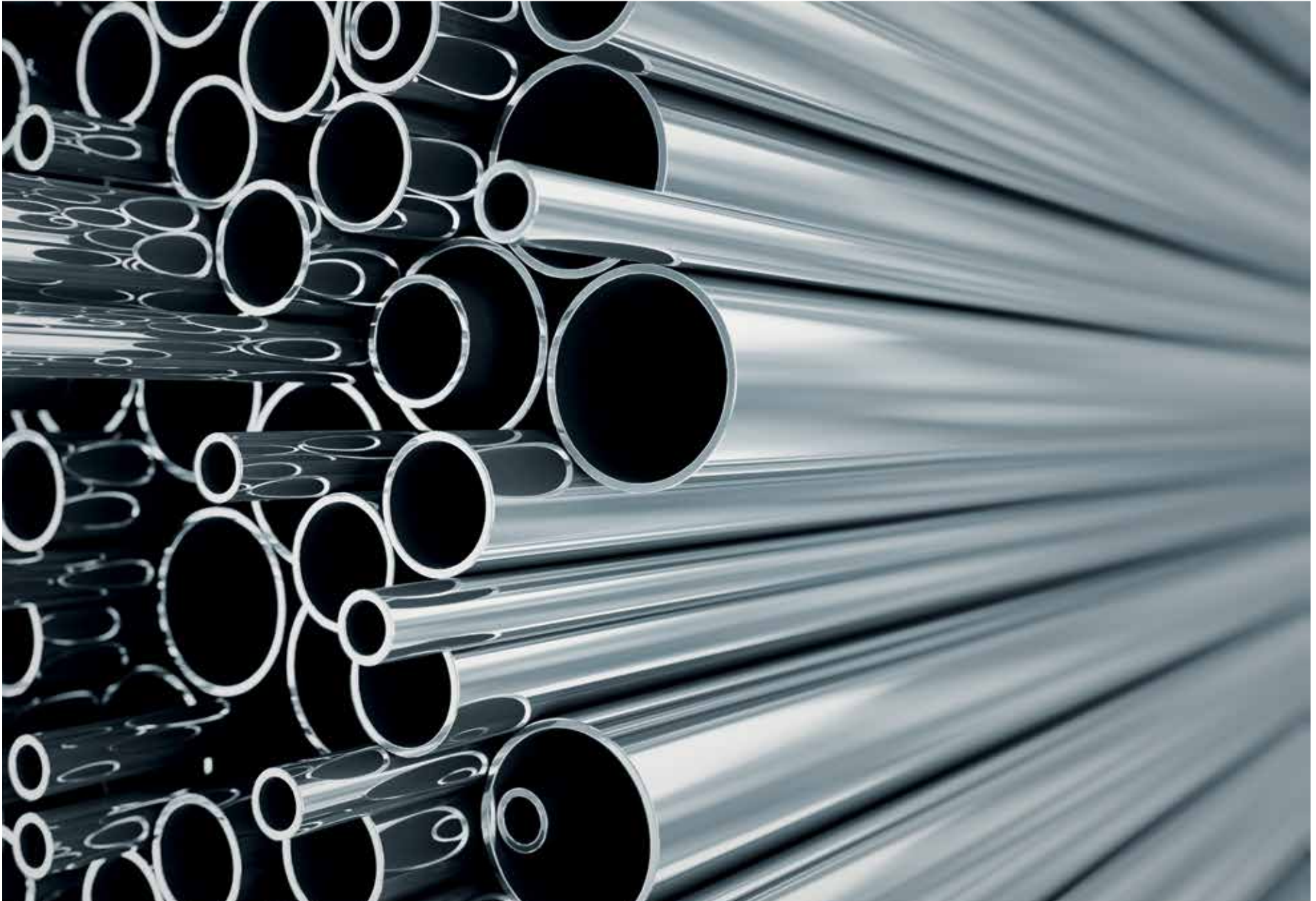

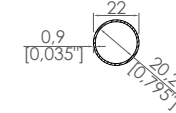
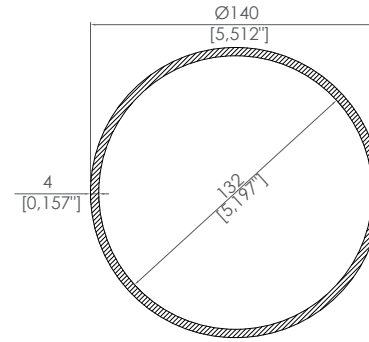
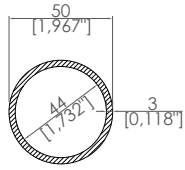

Ürün Kodu / Product Code	11431
Kalınlık / Thickness	3 mm
Ağırlık / Weight	1,197 kg/m 2,639 lb/m

Ürün Kodu / Product Code	2862
Kalınlık / Thickness	4 mm
Ağırlık / Weight	4,631 kg/m 10,21 lb/m

Ürün Kodu / Product Code	20081
Kalınlık / Thickness	0,9 mm
Ağırlık / Weight	0,162 kg/m 0,35715 lb/m

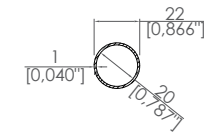
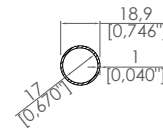
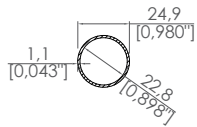

Ürün Kodu / Product Code	20302
Kalınlık / Thickness	1,1 mm
Ağırlık / Weight	0,225 kg/m 0,496 lb/m

Ürün Kodu / Product Code	20056
Kalınlık / Thickness	1 mm
Ağırlık / Weight	0,152 kg/m 0,3351 lb/m

Ürün Kodu / Product Code	20080
Kalınlık / Thickness	1 mm
Ağırlık / Weight	0,179 kg/m 0,3946 lb/m

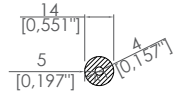

Ürün Kodu / Product Code	2624
Kalınlık / Thickness	5 mm
Ağırlık / Weight	0,385 kg/m 0,8488 lb/m

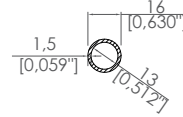

Ürün Kodu / Product Code	2181
Kalınlık / Thickness	1,5 mm
Ağırlık / Weight	0,186 kg/m 0,4101 lb/m

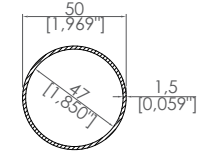

Ürün Kodu / Product Code	2180
Kalınlık / Thickness	1,5 mm
Ağırlık / Weight	0,620 kg/m 1,367 lb/m

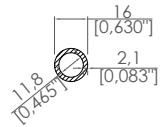

Ürün Kodu / Product Code	2931
Kalınlık / Thickness	2,1 mm
Ağırlık / Weight	0,250 kg/m 0,5512 lb/m

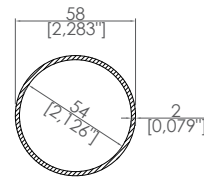

Ürün Kodu / Product Code	2921
Kalınlık / Thickness	2 mm
Ağırlık / Weight	0,954 kg/m 2,103 lb/m

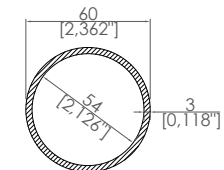

Ürün Kodu / Product Code	43005
Kalınlık / Thickness	3 mm
Ağırlık / Weight	1,455 kg/m 3,208 lb/m

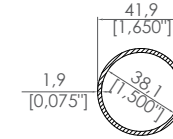
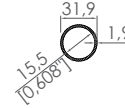
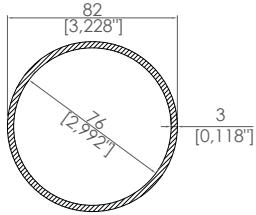

Ürün Kodu / Product Code	21345
Kalınlık / Thickness	3 mm
Ağırlık / Weight	2,019 kg/m 4,451 lb/m

Ürün Kodu / Product Code	2015
Kalınlık / Thickness	1,9 mm
Ağırlık / Weight	0,486 kg/m 1,0714 lb/m

Ürün Kodu / Product Code	2014
Kalınlık / Thickness	1,9 mm
Ağırlık / Weight	0,648 kg/m 1,4286 lb/m

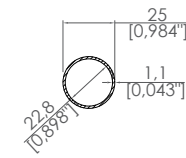
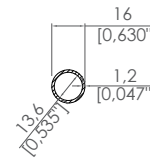
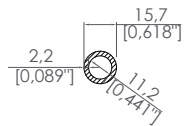

Ürün Kodu / Product Code	0038
Kalınlık / Thickness	2,2 mm
Ağırlık / Weight	0,260 kg/m 0,5732 lb/m

Ürün Kodu / Product Code	3472
Kalınlık / Thickness	1,2 mm
Ağırlık / Weight	0,152 kg/m 0,3351 lb/m

Ürün Kodu / Product Code	20302
Kalınlık / Thickness	1,1 mm
Ağırlık / Weight	0,225 kg/m 0,496 lb/m

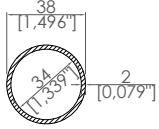

Ürün Kodu / Product Code	20298
Kalınlık / Thickness	2 mm
Ağırlık / Weight	0,612 kg/m 1,3492 lb/m

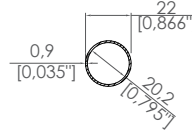

Ürün Kodu / Product Code	20081
Kalınlık / Thickness	0,9 mm
Ağırlık / Weight	0,162 kg/m 0,35715 lb/m

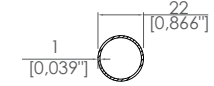

Ürün Kodu / Product Code	20080
Kalınlık / Thickness	1 mm
Ağırlık / Weight	0,179 kg/m 0,3946 lb/m

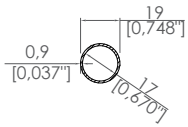

Ürün Kodu / Product Code	20056
Kalınlık / Thickness	0,9 mm
Ağırlık / Weight	0,152 kg/m 0,3351 lb/m

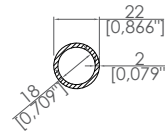

Ürün Kodu / Product Code	8152
Kalınlık / Thickness	2 mm
Ağırlık / Weight	0,342 kg/m 0,754 lb/m

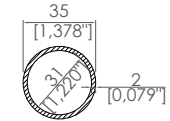

Ürün Kodu / Product Code	3473
Kalınlık / Thickness	2 mm
Ağırlık / Weight	0,561 kg/m 1,2368 lb/m

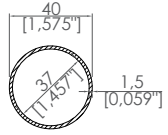

Ürün Kodu / Product Code	3474
Kalınlık / Thickness	1,5 mm
Ağırlık / Weight	0,491 kg/m 1,0825 lb/m

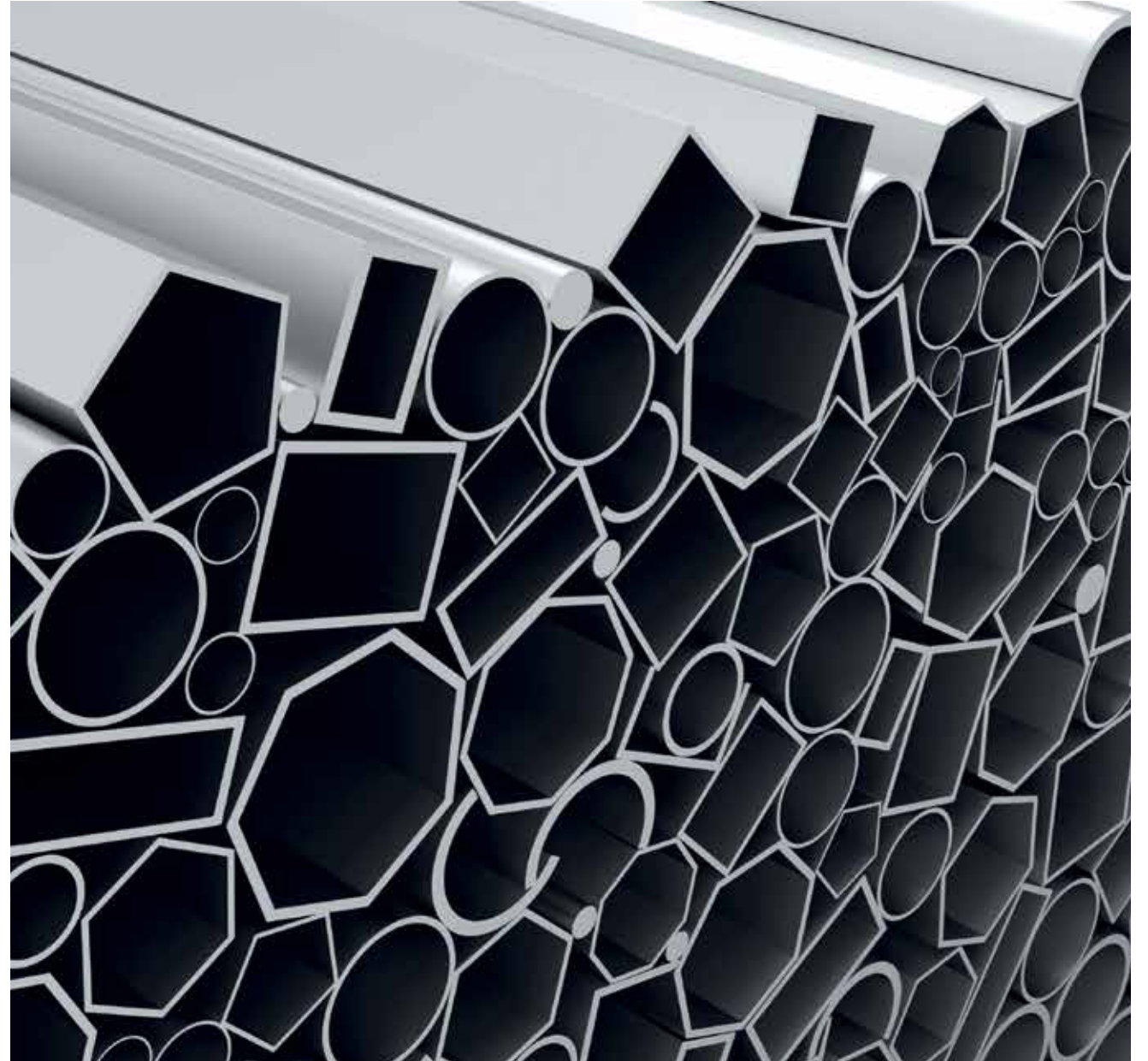

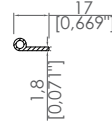

Ürün Kodu / Product Code	3262
Kalınlık / Thickness	1,8 mm
Ağırlık / Weight	0,103 kg/m 0,22708 lb/m

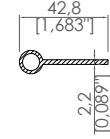

Ürün Kodu / Product Code	37212
Kalınlık / Thickness	2,2 mm
Ağırlık / Weight	0,318 kg/m 0,701 lb/m

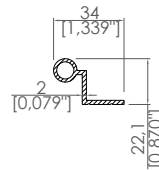

Ürün Kodu / Product Code	37214
Kalınlık / Thickness	2 mm
Ağırlık / Weight	0,326 kg/m 0,7187 lb/m

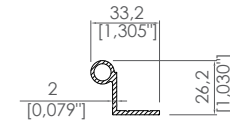

Ürün Kodu / Product Code	37213
Kalınlık / Thickness	2 mm
Ağırlık / Weight	0,346 kg/m 0,76289 lb/m



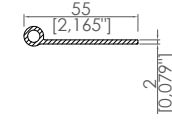
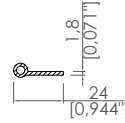
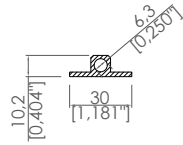

Ürün Kodu / Product Code	3166
Kalınlık / Thickness	6,3 mm
Ağırlık / Weight	0,297 kg/m 0,6548 lb/m

Ürün Kodu / Product Code	3167
Kalınlık / Thickness	1,8 mm
Ağırlık / Weight	0,149 kg/m 0,3285 lb/m

Ürün Kodu / Product Code	3168
Kalınlık / Thickness	2 mm
Ağırlık / Weight	0,369 kg/m 0,8135 lb/m

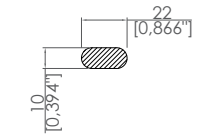
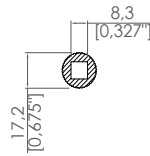
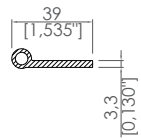

Ürün Kodu / Product Code	3169
Kalınlık / Thickness	3,3 mm
Ağırlık / Weight	0,387 kg/m 0,8532 lb/m

Ürün Kodu / Product Code	3223
Kalınlık / Thickness	8,3 mm
Ağırlık / Weight	0,420 kg/m 0,926 lb/m

Ürün Kodu / Product Code	3239
Kalınlık / Thickness	10 mm
Ağırlık / Weight	0,540 kg/m 1,1905 lb/m

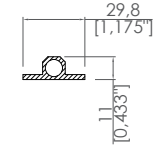
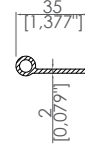
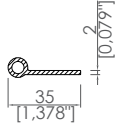

Ürün Kodu / Product Code	3256
Kalınlık / Thickness	2 mm
Ağırlık / Weight	0,260 kg/m 0,5732 lb/m

Ürün Kodu / Product Code	3257
Kalınlık / Thickness	2 mm
Ağırlık / Weight	0,257 kg/m 0,5666 lb/m

Ürün Kodu / Product Code	3258
Kalınlık / Thickness	11 mm
Ağırlık / Weight	0,285 kg/m 0,6283 lb/m

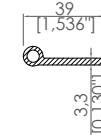
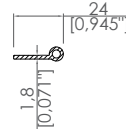
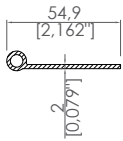

Ürün Kodu / Product Code	3259
Kalınlık / Thickness	2 mm
Ağırlık / Weight	0,366 kg/m 0,8069 lb/m

Ürün Kodu / Product Code	3260
Kalınlık / Thickness	1,8 mm
Ağırlık / Weight	0,152 kg/m 0,3351 lb/m

Ürün Kodu / Product Code	3261
Kalınlık / Thickness	3,3 mm
Ağırlık / Weight	0,390 kg/m 0,8598 lb/m

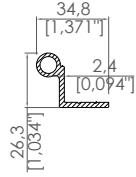

Ürün Kodu / Product Code	2053
Kalınlık / Thickness	2,4 mm
Ağırlık / Weight	0,423 kg/m 0,9326 lb/m

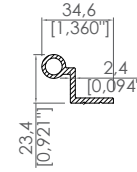

Ürün Kodu / Product Code	2054
Kalınlık / Thickness	2,4 mm
Ağırlık / Weight	0,399 kg/m 0,8796 lb/m

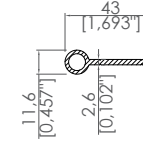

Ürün Kodu / Product Code	2055
Kalınlık / Thickness	2,6 mm
Ağırlık / Weight	0,369 kg/m 0,8135 lb/m

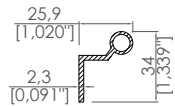

Ürün Kodu / Product Code	2151
Kalınlık / Thickness	2,3 mm
Ağırlık / Weight	0,350 kg/m 0,7716 lb/m

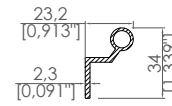

Ürün Kodu / Product Code	2152
Kalınlık / Thickness	2,3 mm
Ağırlık / Weight	0,333 kg/m 0,7341 lb/m

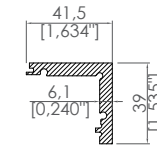

Ürün Kodu / Product Code	2373
Kalınlık / Thickness	6,1 mm
Ağırlık / Weight	1,131 kg/m 2,4934 lb/m

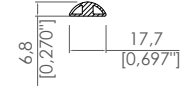

Ürün Kodu / Product Code	3366
Kalınlık / Thickness	6,8 mm
Ağırlık / Weight	0,171 kg/m 0,377 lb/m

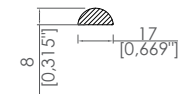

Ürün Kodu / Product Code	3243
Kalınlık / Thickness	8 mm
Ağırlık / Weight	0,285 kg/m 0,6283 lb/m

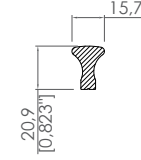
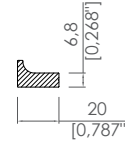
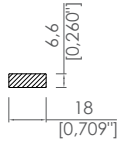

Ürün Kodu / Product Code	37091
Kalınlık / Thickness	6,6 mm
Ağırlık / Weight	0,320 kg/m 0,7099 lb/m

Ürün Kodu / Product Code	37092
Kalınlık / Thickness	6,8 mm
Ağırlık / Weight	0,428 kg/m 0,9438 lb/m

Ürün Kodu / Product Code	37123
Kalınlık / Thickness	15,7 mm
Ağırlık / Weight	0,488 kg/m 1,0759 lb/m

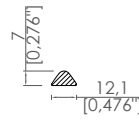
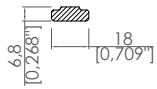

Ürün Kodu / Product Code	37124
Kalınlık / Thickness	6,8 mm
Ağırlık / Weight	0,293 kg/m 0,646 lb/m

Ürün Kodu / Product Code	2072
Kalınlık / Thickness	7 mm
Ağırlık / Weight	0,153 kg/m 0,3373 lb/m

Ürün Kodu / Product Code	2073
Kalınlık / Thickness	7 mm
Ağırlık / Weight	0,206 kg/m 0,45415 lb/m

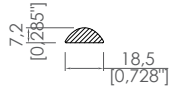

Ürün Kodu / Product Code	2074
Kalınlık / Thickness	7,2 mm
Ağırlık / Weight	0,261 kg/m 0,5754 lb/m

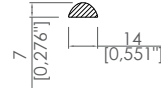

Ürün Kodu / Product Code	2429
Kalınlık / Thickness	7 mm
Ağırlık / Weight	0,198 kg/m 0,4365 lb/m



Ürün Kodu / Product Code	2430
Kalınlık / Thickness	7 mm
Ağırlık / Weight	0,245 kg/m 0,5401 lb/m

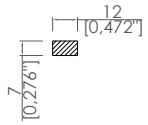

Ürün Kodu / Product Code	2431
Kalınlık / Thickness	7 mm
Ağırlık / Weight	0,228 kg/m 0,5027 lb/m

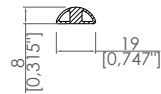

Ürün Kodu / Product Code	2627
Kalınlık / Thickness	8 mm
Ağırlık / Weight	0,212 kg/m 0,4674 lb/m

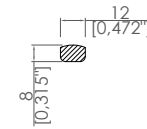

Ürün Kodu / Product Code	2146
Kalınlık / Thickness	8 mm
Ağırlık / Weight	0,241 kg/m 0,5313 lb/m



Ürün Kodu / Product Code	37054
Kalınlık / Thickness	7,9 mm
Ağırlık / Weight	0,247 kg/m 0,5445 lb/m

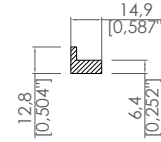

Ürün Kodu / Product Code	37055
Kalınlık / Thickness	6,4 mm
Ağırlık / Weight	0,306 kg/m 0,6746 lb/m

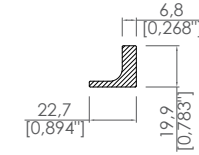

Ürün Kodu / Product Code	37056
Kalınlık / Thickness	6,8 mm
Ağırlık / Weight	0,507 kg/m 1,1177 lb/m



Ürün Kodu / Product Code	37057
Kalınlık / Thickness	7 mm
Ağırlık / Weight	0,209 kg/m 0,4608 lb/m

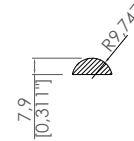

Ürün Kodu / Product Code	37058
Kalınlık / Thickness	7,9 mm
Ağırlık / Weight	0,306 kg/m 0,6746 lb/m

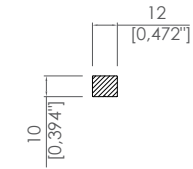

Ürün Kodu / Product Code	37090
Kalınlık / Thickness	10 mm
Ağırlık / Weight	0,325 kg/m 0,7165 lb/m



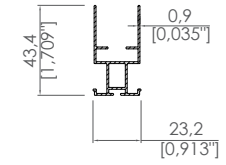

Ürün Kodu / Product Code	2629
Kalınlık / Thickness	0,9 mm
Ağırlık / Weight	0,365 kg/m 0,8047 lb/m

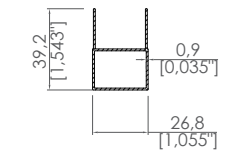

Ürün Kodu / Product Code	2628
Kalınlık / Thickness	0,9 mm
Ağırlık / Weight	0,314 kg/m 0,6923 lb/m

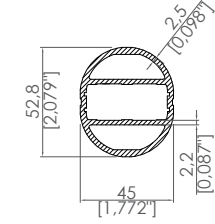

Ürün Kodu / Product Code	42103
Kalınlık / Thickness	2,2 mm
Ağırlık / Weight	1,564 kg/m 3,448 lb/m

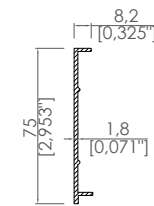
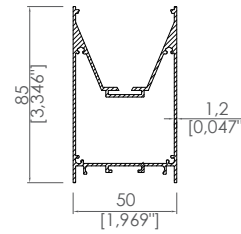
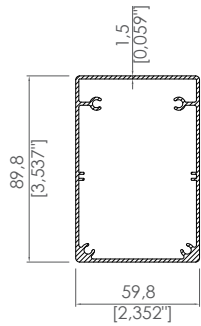

Ürün Kodu / Product Code	2607
Kalınlık / Thickness	1,5 mm
Ağırlık / Weight	1,510 kg/m 3,329 lb/m

Ürün Kodu / Product Code	2442
Kalınlık / Thickness	1,2 mm
Ağırlık / Weight	1,276 kg/m 2,813 lb/m

Ürün Kodu / Product Code	2443
Kalınlık / Thickness	1,8 mm
Ağırlık / Weight	0,431 kg/m 0,9105 lb/m

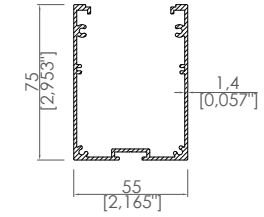
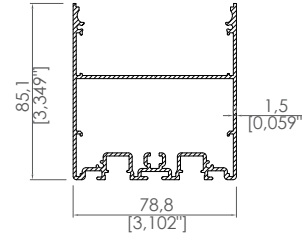
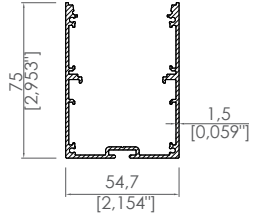

Ürün Kodu / Product Code	2215
Kalınlık / Thickness	1,5 mm
Ağırlık / Weight	1,188 kg/m 2,619 lb/m

Ürün Kodu / Product Code	2216
Kalınlık / Thickness	1,5 mm
Ağırlık / Weight	1,831 kg/m 4,037 lb/m

Ürün Kodu / Product Code	2209
Kalınlık / Thickness	1,4 mm
Ağırlık / Weight	1,148 kg/m 2,531 lb/m

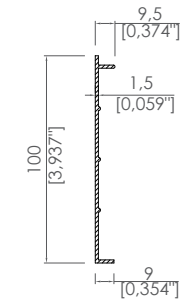
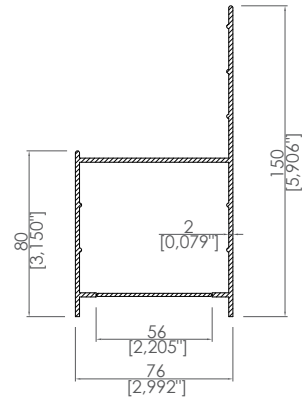
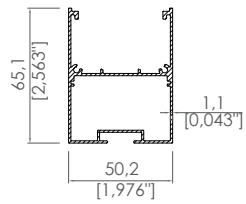

Ürün Kodu / Product Code	2608
Kalınlık / Thickness	1,1 mm
Ağırlık / Weight	0,879 kg/m 1,938 lb/m

Ürün Kodu / Product Code	2218
Kalınlık / Thickness	2 mm
Ağırlık / Weight	1,976 kg/m 4,356 lb/m

Ürün Kodu / Product Code	2273
Kalınlık / Thickness	1,5 mm
Ağırlık / Weight	0,482 kg/m 1,0626 lb/m

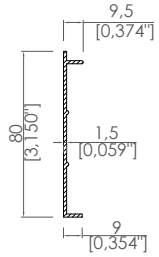

Ürün Kodu / Product Code	2274
Kalınlık / Thickness	1,5 mm
Ağırlık / Weight	0,397 kg/m 0,8752 lb/m

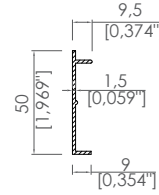

Ürün Kodu / Product Code	2275
Kalınlık / Thickness	1,5 mm
Ağırlık / Weight	0,270 kg/m 0,5952 lb/m

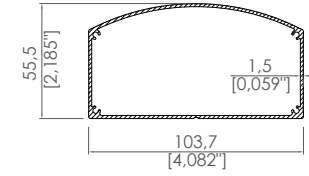

Ürün Kodu / Product Code	2206
Kalınlık / Thickness	1,5 mm
Ağırlık / Weight	1,246 kg/m 2,747 lb/m

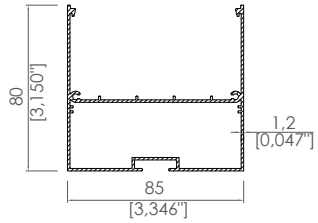

Ürün Kodu / Product Code	2763
Kalınlık / Thickness	1,2 mm
Ağırlık / Weight	1,247 kg/m 2,749 lb/m

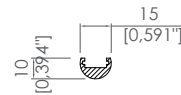

Ürün Kodu / Product Code	42010
Kalınlık / Thickness	10 mm
Ağırlık / Weight	0,200 kg/m 0,4409 lb/m

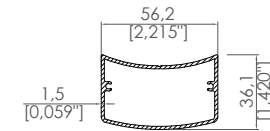

Ürün Kodu / Product Code	2406
Kalınlık / Thickness	1,5 mm
Ağırlık / Weight	0,748 kg/m 1,649 lb/m

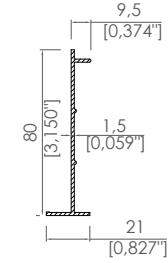
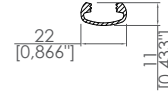
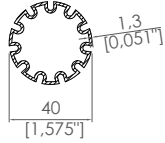

Ürün Kodu / Product Code	42001
Kalınlık / Thickness	1,3 mm
Ağırlık / Weight	0,677 kg/m 1,4925 lb/m

Ürün Kodu / Product Code	37098
Kalınlık / Thickness	11 mm
Ağırlık / Weight	0,190 kg/m 0,4189 lb/m

Ürün Kodu / Product Code	2276
Kalınlık / Thickness	1,5 mm
Ağırlık / Weight	0,446 kg/m 0,9833 lb/m

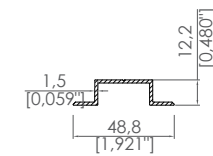
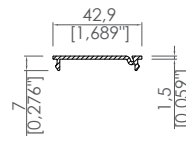
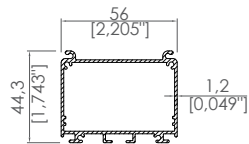

Ürün Kodu / Product Code	2277
Kalınlık / Thickness	1,2 mm
Ağırlık / Weight	0,845 kg/m 1,863 lb/m

Ürün Kodu / Product Code	2217
Kalınlık / Thickness	1,5 mm
Ağırlık / Weight	0,230 kg/m 0,5071 lb/m

Ürün Kodu / Product Code	2353
Kalınlık / Thickness	1,5 mm
Ağırlık / Weight	0,282 kg/m 0,6217 lb/m

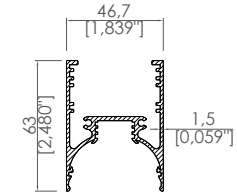
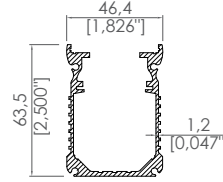
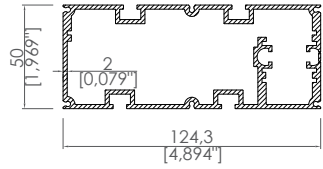

Ürün Kodu / Product Code	2354
Kalınlık / Thickness	2 mm
Ağırlık / Weight	2,843 kg/m 6,268 lb/m

Ürün Kodu / Product Code	42002
Kalınlık / Thickness	1,2 mm
Ağırlık / Weight	1,297 kg/m 2,8594 lb/m

Ürün Kodu / Product Code	42004
Kalınlık / Thickness	1,5 mm
Ağırlık / Weight	0,413 kg/m 0,9105 lb/m

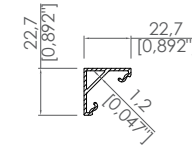
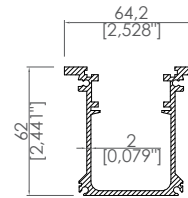
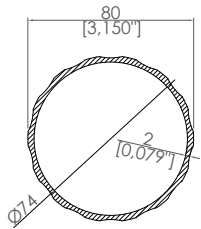

Ürün Kodu / Product Code	42003
Kalınlık / Thickness	2 mm
Ağırlık / Weight	0,623 kg/m 1,3735 lb/m

Ürün Kodu / Product Code	42005
Kalınlık / Thickness	2 mm
Ağırlık / Weight	0,530 kg/m 1,1684 lb/m

Ürün Kodu / Product Code	3085
Kalınlık / Thickness	1,2 mm
Ağırlık / Weight	0,250 kg/m 0,5512 lb/m

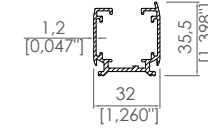
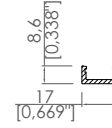
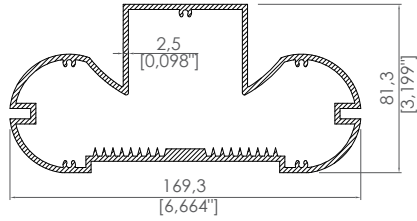

Ürün Kodu / Product Code	3267
Kalınlık / Thickness	2,5 mm
Ağırlık / Weight	4,190 kg/m 9,237 lb/m

Ürün Kodu / Product Code	42009
Kalınlık / Thickness	8,6 mm
Ağırlık / Weight	0,160 kg/m 0,35274 lb/m

Ürün Kodu / Product Code	2303
Kalınlık / Thickness	1,2 mm
Ağırlık / Weight	0,527 kg/m 1,1618 lb/m

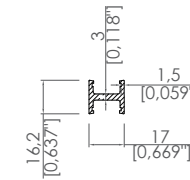
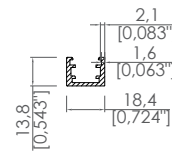
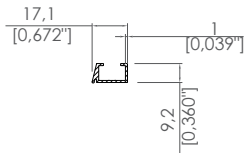

Ürün Kodu / Product Code	3356
Kalınlık / Thickness	1 mm
Ağırlık / Weight	0,119 kg/m 0,26235 lb/m

Ürün Kodu / Product Code	42007
Kalınlık / Thickness	1,6 mm
Ağırlık / Weight	0,251 kg/m 0,5534 lb/m

Ürün Kodu / Product Code	42011
Kalınlık / Thickness	1,5 mm
Ağırlık / Weight	0,276 kg/m 0,6085 lb/m

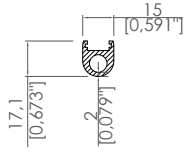

Ürün Kodu / Product Code	42012
Kalınlık / Thickness	2 mm
Ağırlık / Weight	0,333 kg/m 0,7341 lb/m

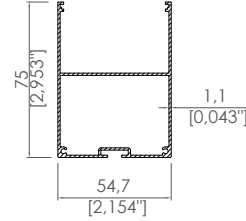

Ürün Kodu / Product Code	2600
Kalınlık / Thickness	1,1 mm
Ağırlık / Weight	0,859 kg/m 1,8938 lb/m

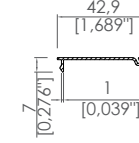

Ürün Kodu / Product Code	2601
Kalınlık / Thickness	1 mm
Ağırlık / Weight	0,160 kg/m 0,35274 lb/m

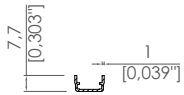

Ürün Kodu / Product Code	2602
Kalınlık / Thickness	1 mm
Ağırlık / Weight	0,076 kg/m 0,16755 lb/m

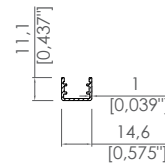

Ürün Kodu / Product Code	2603
Kalınlık / Thickness	1 mm
Ağırlık / Weight	0,120 kg/m 0,26455 lb/m

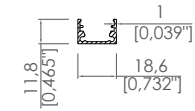

Ürün Kodu / Product Code	2604
Kalınlık / Thickness	1 mm
Ağırlık / Weight	0,160 kg/m 0,35274 lb/m

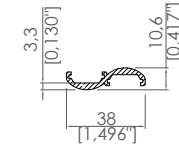
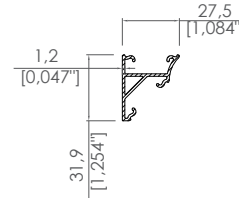
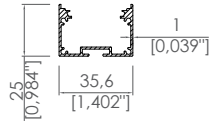

Ürün Kodu / Product Code	2605
Kalınlık / Thickness	1 mm
Ağırlık / Weight	0,380 kg/m 0,8378 lb/m

Ürün Kodu / Product Code	3086
Kalınlık / Thickness	1,2 mm
Ağırlık / Weight	0,352 kg/m 0,776 lb/m

Ürün Kodu / Product Code	2296
Kalınlık / Thickness	3,3 mm
Ağırlık / Weight	0,321 kg/m 0,7077 lb/m

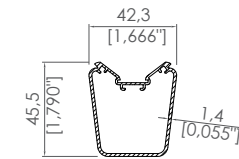
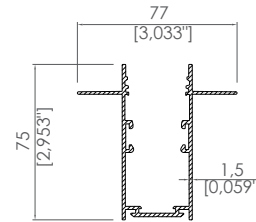
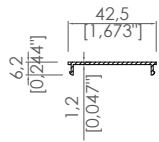

Ürün Kodu / Product Code	2599
Kalınlık / Thickness	1,2 mm
Ağırlık / Weight	0,171 kg/m 0,377 lb/m

Ürün Kodu / Product Code	2587
Kalınlık / Thickness	1,5 mm
Ağırlık / Weight	1,087 kg/m 2,3964 lb/m

Ürün Kodu / Product Code	2588
Kalınlık / Thickness	1,4 mm
Ağırlık / Weight	0,640 kg/m 1,411 lb/m

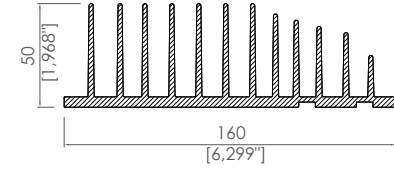
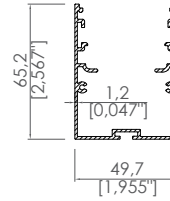
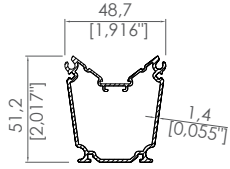

Ürün Kodu / Product Code	2593
Kalınlık / Thickness	1,4 mm
Ağırlık / Weight	0,827 kg/m 1,8232 lb/m

Ürün Kodu / Product Code	2613
Kalınlık / Thickness	1,2 mm
Ağırlık / Weight	0,945 kg/m 2,0834 lb/m

Ürün Kodu / Product Code	3164
Kalınlık / Thickness	50 mm
Ağırlık / Weight	5,265 kg/m 11,607 lb/m

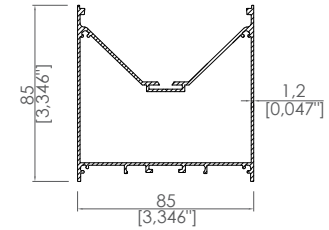
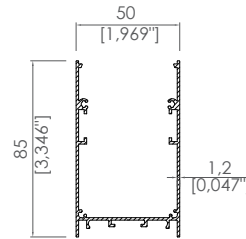
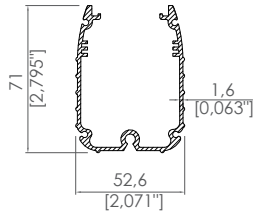

Ürün Kodu / Product Code	2445
Kalınlık / Thickness	1,6 mm
Ağırlık / Weight	1,215 kg/m 2,6786 lb/m

Ürün Kodu / Product Code	2598
Kalınlık / Thickness	1,2 mm
Ağırlık / Weight	0,930 kg/m 2,0503 lb/m

Ürün Kodu / Product Code	2441
Kalınlık / Thickness	1,2 mm
Ağırlık / Weight	1,420 kg/m 3,1306 lb/m

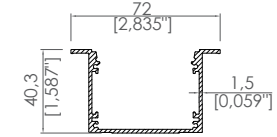
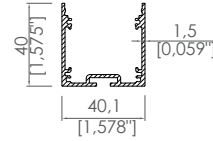
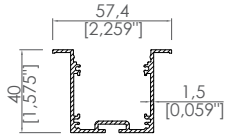

Ürün Kodu / Product Code	2211
Kalınlık / Thickness	1,5 mm
Ağırlık / Weight	0,720 kg/m 1,5873 lb/m

Ürün Kodu / Product Code	2212
Kalınlık / Thickness	1,5 mm
Ağırlık / Weight	0,655 kg/m 1,444 lb/m

Ürün Kodu / Product Code	2213
Kalınlık / Thickness	1,5 mm
Ağırlık / Weight	0,840 kg/m 1,852 lb/m

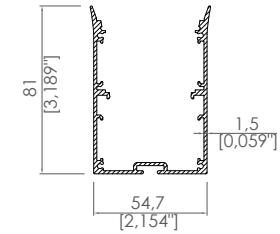
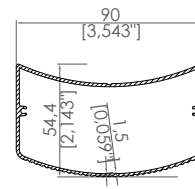
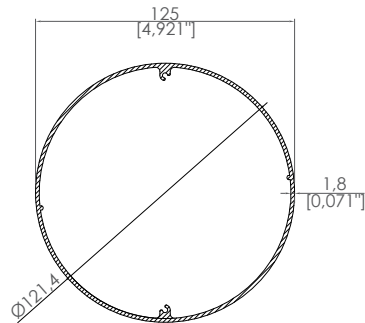

Ürün Kodu / Product Code	2200
Kalınlık / Thickness	1,8 mm
Ağırlık / Weight	2,030 kg/m 4,475 lb/m

Ürün Kodu / Product Code	2205
Kalınlık / Thickness	1,5 mm
Ağırlık / Weight	1,083 kg/m 0,183 lb/m

Ürün Kodu / Product Code	2214
Kalınlık / Thickness	1,5 mm
Ağırlık / Weight	1,250 kg/m 2,756 lb/m

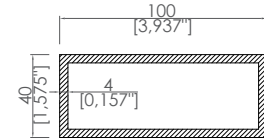
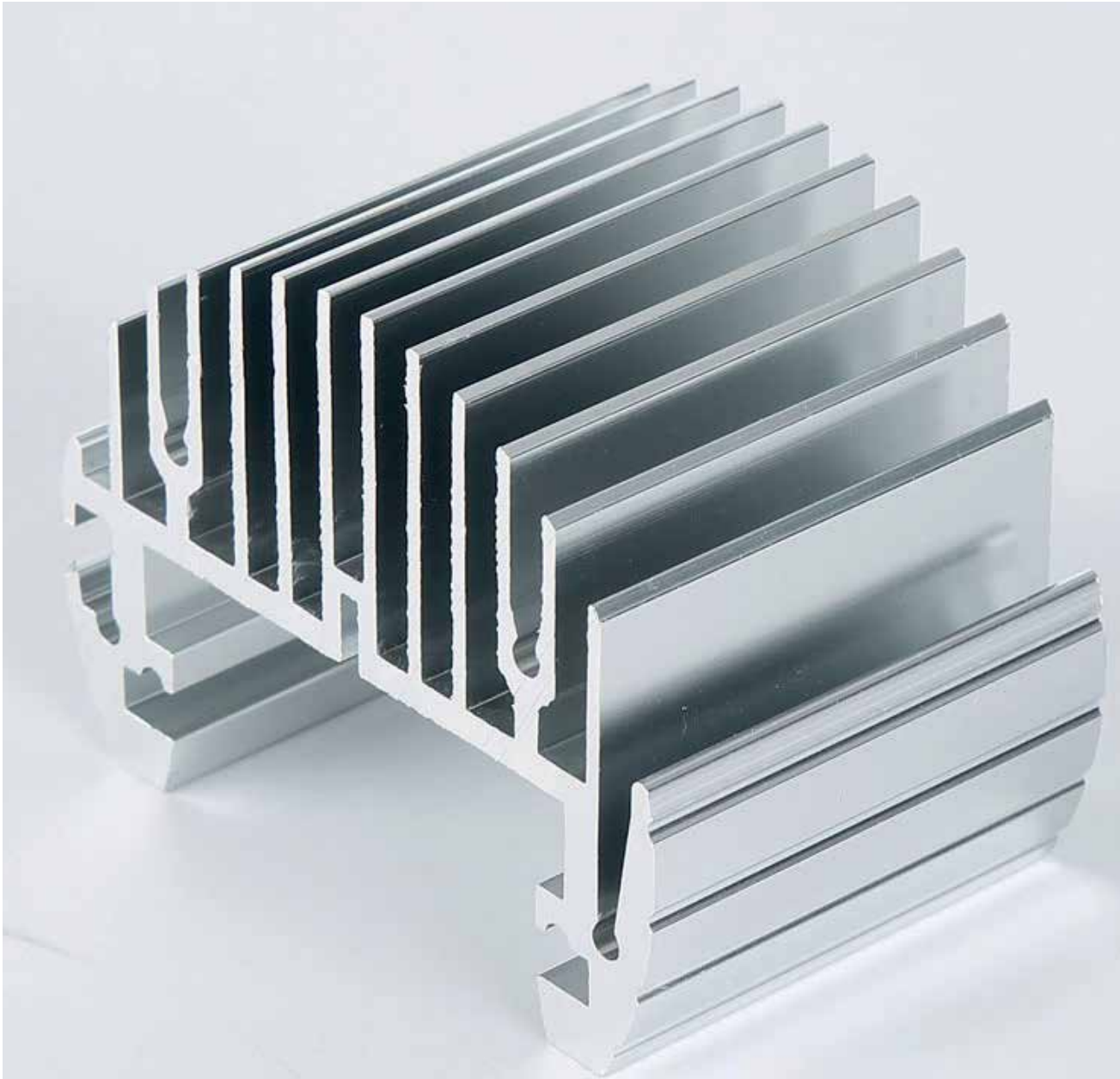

Ürün Kodu / Product Code	43002
Kalınlık / Thickness	4 mm
Ağırlık / Weight	2,861 kg/m 6,307 lb/m

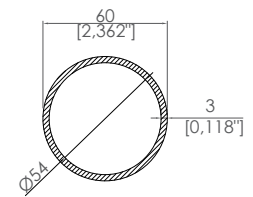

Ürün Kodu / Product Code	43005
Kalınlık / Thickness	3 mm
Ağırlık / Weight	1,455 kg/m 3,208 lb/m

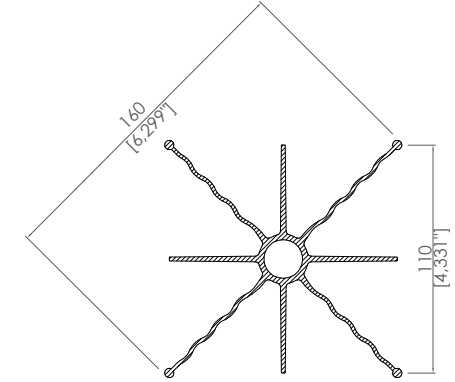
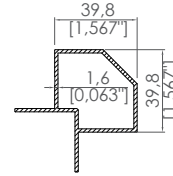
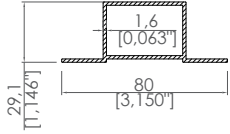

Ürün Kodu / Product Code	37049
Kalınlık / Thickness	1,6 mm
Ağırlık / Weight	0,745 kg/m 1,6424 lb/m

Ürün Kodu / Product Code	37050
Kalınlık / Thickness	1,6 mm
Ağırlık / Weight	0,788 kg/m 1,7372 lb/m

Ürün Kodu / Product Code	43001
Kalınlık / Thickness	1,5 mm
Ağırlık / Weight	2,943 kg/m 6,488 lb/m

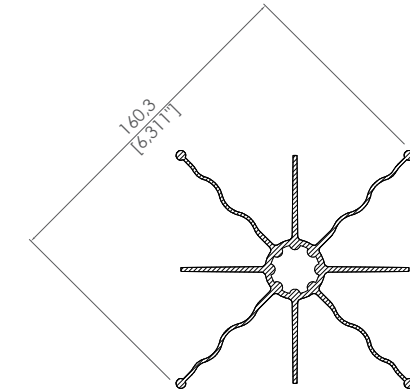
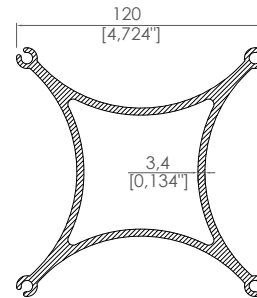
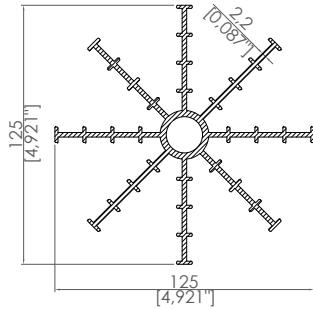

Ürün Kodu / Product Code	43003
Kalınlık / Thickness	2,2 mm
Ağırlık / Weight	3,615 kg/m 7,97 lb/m

Ürün Kodu / Product Code	43004
Kalınlık / Thickness	3,4 mm
Ağırlık / Weight	4,658 kg/m 10,27 lb/m

Ürün Kodu / Product Code	43006
Kalınlık / Thickness	1,5 mm
Ağırlık / Weight	3,124 kg/m 6,887 lb/m

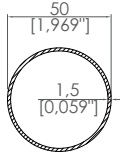

Ürün Kodu / Product Code	2180
Kalınlık / Thickness	1,5 mm
Ağırlık / Weight	0,620 kg/m 1,367 lb/m

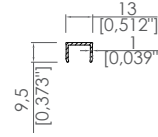

Ürün Kodu / Product Code	3466
Kalınlık / Thickness	1 mm
Ağırlık / Weight	0,087 kg/m 0,1918 lb/m

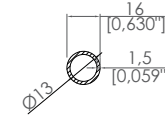

Ürün Kodu / Product Code	2181
Kalınlık / Thickness	1,5 mm
Ağırlık / Weight	0,186 kg/m 0,4101 lb/m

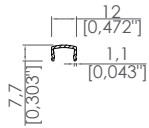

Ürün Kodu / Product Code	3464
Kalınlık / Thickness	1,1 mm
Ağırlık / Weight	0,073 kg/m 0,16094 lb/m

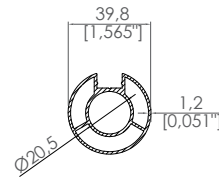

Ürün Kodu / Product Code	3463
Kalınlık / Thickness	1,2 mm
Ağırlık / Weight	0,735 kg/m 1,6204 lb/m

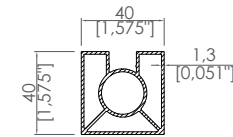

Ürün Kodu / Product Code	3465
Kalınlık / Thickness	1,3 mm
Ağırlık / Weight	0,927 kg/m 2,0437 lb/m

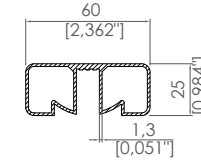
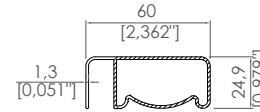
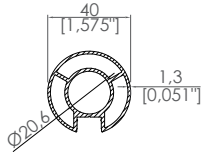

Ürün Kodu / Product Code	2182
Kalınlık / Thickness	1,3 mm
Ağırlık / Weight	0,808 kg/m 1,7813 lb/m

Ürün Kodu / Product Code	3469
Kalınlık / Thickness	1,3 mm
Ağırlık / Weight	0,629 kg/m 1,3867 lb/m

Ürün Kodu / Product Code	3471
Kalınlık / Thickness	1,3 mm
Ağırlık / Weight	0,786 kg/m 1,733 lb/m

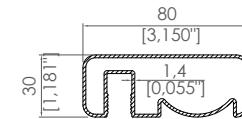
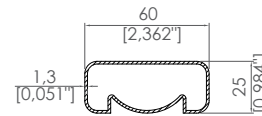

Ürün Kodu / Product Code	3470
Kalınlık / Thickness	1,3 mm
Ağırlık / Weight	0,610 kg/m 1,3228 lb/m

Ürün Kodu / Product Code	3468
Kalınlık / Thickness	1,4 mm
Ağırlık / Weight	1,022 kg/m 2,209 lb/m



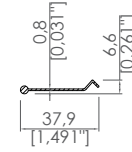

Ürün Kodu / Product Code	3385
Kalınlık / Thickness	0,8 mm
Ağırlık / Weight	0,111 kg/m 0,2447 lb/m

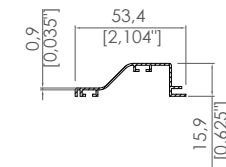

Ürün Kodu / Product Code	3386
Kalınlık / Thickness	0,9 mm
Ağırlık / Weight	0,250 kg/m 0,5512 lb/m



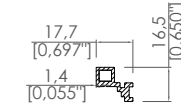
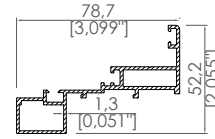
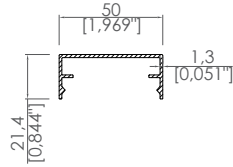

Ürün Kodu / Product Code	2349
Kalınlık / Thickness	1,3 mm
Ağırlık / Weight	0,400 kg/m 0,8818 lb/m

Ürün Kodu / Product Code	2361
Kalınlık / Thickness	1,3 mm
Ağırlık / Weight	0,938 kg/m 2,068 lb/m

Ürün Kodu / Product Code	2351
Kalınlık / Thickness	1,4 mm
Ağırlık / Weight	0,253 kg/m 0,5578 lb/m

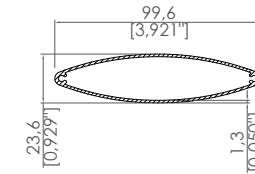
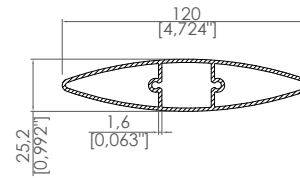
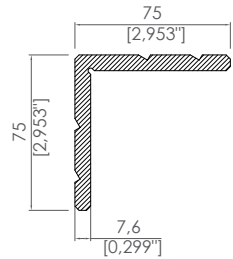

Ürün Kodu / Product Code	2364
Kalınlık / Thickness	7,6 mm
Ağırlık / Weight	2,819 kg/m 6,215 lb/m

Ürün Kodu / Product Code	37106
Kalınlık / Thickness	1,6 mm
Ağırlık / Weight	1,325 kg/m 2,921 lb/m

Ürün Kodu / Product Code	3467
Kalınlık / Thickness	1,3 mm
Ağırlık / Weight	0,748 kg/m 1,649 lb/m

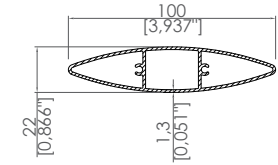
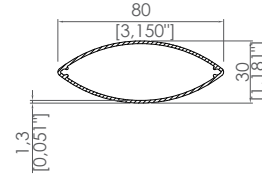
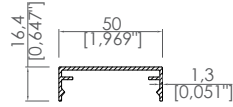

Ürün Kodu / Product Code	2362
Kalınlık / Thickness	1,3 mm
Ağırlık / Weight	0,364 kg/m 0,8025 lb/m

Ürün Kodu / Product Code	2596
Kalınlık / Thickness	1,3 mm
Ağırlık / Weight	0,626 kg/m 1,38 lb/m

Ürün Kodu / Product Code	2398
Kalınlık / Thickness	1,3 mm
Ağırlık / Weight	0,908 kg/m 2,0018 lb/m

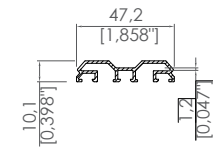
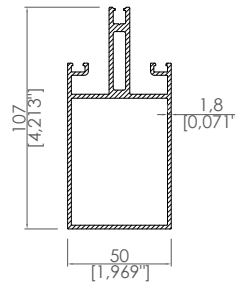
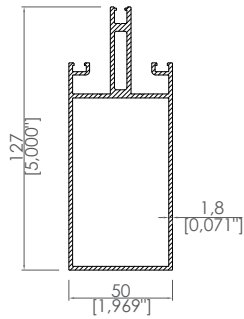

Ürün Kodu / Product Code	2346
Kalınlık / Thickness	1,8 mm
Ağırlık / Weight	2,115 kg/m 4,663 lb/m

Ürün Kodu / Product Code	2347
Kalınlık / Thickness	1,8 mm
Ağırlık / Weight	1,920 kg/m 4,233 lb/m

Ürün Kodu / Product Code	2350
Kalınlık / Thickness	1,2 mm
Ağırlık / Weight	0,353 kg/m 0,7782 lb/m

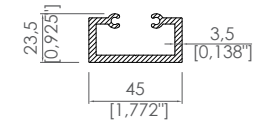
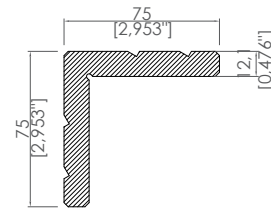
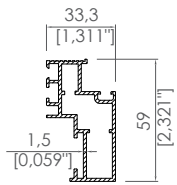

Ürün Kodu / Product Code	2352
Kalınlık / Thickness	1,5 mm
Ağırlık / Weight	0,884 kg/m 1,494 lb/m

Ürün Kodu / Product Code	2363
Kalınlık / Thickness	12,1 mm
Ağırlık / Weight	4,407 kg/m 9,716 lb/m

Ürün Kodu / Product Code	2348
Kalınlık / Thickness	3,5 mm
Ağırlık / Weight	0,981 kg/m 2,1627 lb/m



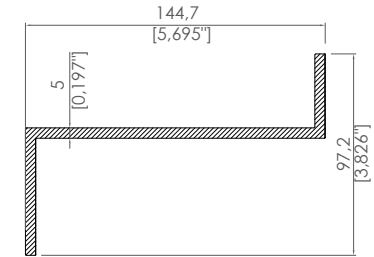
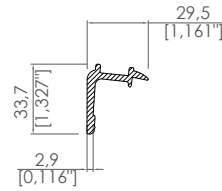
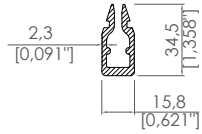

Ürün Kodu / Product Code	3339
Kalınlık / Thickness	2,3 mm
Ağırlık / Weight	0,621 kg/m 1,369 lb/m

Ürün Kodu / Product Code	3340
Kalınlık / Thickness	2,9 mm
Ağırlık / Weight	0,539 kg/m 1,1883 lb/m

Ürün Kodu / Product Code	3505
Kalınlık / Thickness	5 mm
Ağırlık / Weight	3,190 kg/m 7,033 lb/m

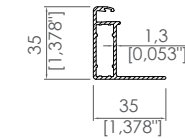
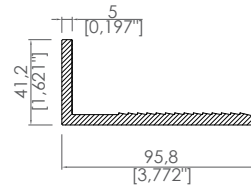
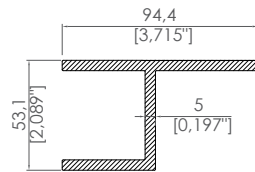

Ürün Kodu / Product Code	3503
Kalınlık / Thickness	5 mm
Ağırlık / Weight	2,461 kg/m 5,426 lb/m

Ürün Kodu / Product Code	3506
Kalınlık / Thickness	5 mm
Ağırlık / Weight	1,856 kg/m 4,092 lb/m

Ürün Kodu / Product Code	3272
Kalınlık / Thickness	1,3 mm
Ağırlık / Weight	0,423 kg/m 0,9326 lb/m

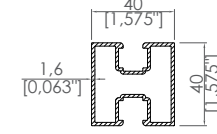
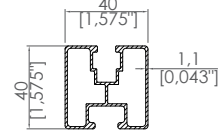
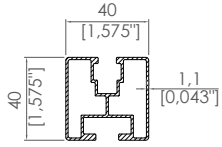

Ürün Kodu / Product Code	3338
Kalınlık / Thickness	1,1 mm
Ağırlık / Weight	0,797 kg/m 1,757 lb/m

Ürün Kodu / Product Code	3287
Kalınlık / Thickness	1,1 mm
Ağırlık / Weight	0,764 kg/m 1,6843 lb/m

Ürün Kodu / Product Code	3534
Kalınlık / Thickness	1,6 mm
Ağırlık / Weight	0,905 kg/m 1,995 lb/m

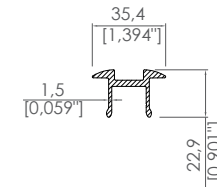
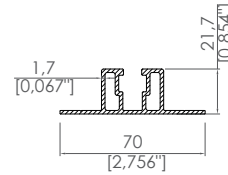
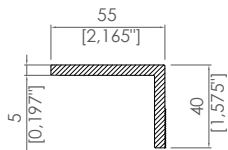

Ürün Kodu / Product Code	3504
Kalınlık / Thickness	5 mm
Ağırlık / Weight	1,230 kg/m 2,7117 lb/m

Ürün Kodu / Product Code	3507
Kalınlık / Thickness	1,7 mm
Ağırlık / Weight	0,794 kg/m 1,7505 lb/m

Ürün Kodu / Product Code	3341
Kalınlık / Thickness	1,5 mm
Ağırlık / Weight	0,477 kg/m 1,0516 lb/m

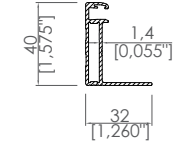

Ürün Kodu / Product Code	3476
Kalınlık / Thickness	1,4 mm
Ağırlık / Weight	0,461 kg/m 1,0163 lb/m

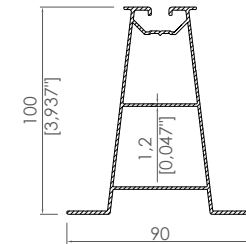

Ürün Kodu / Product Code	3290
Kalınlık / Thickness	1,2 mm
Ağırlık / Weight	1,327 kg/m 2,9255 lb/m



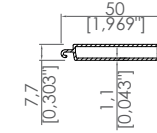
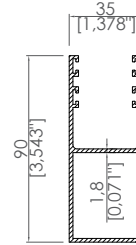
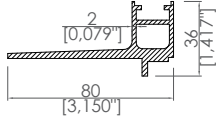

Ürün Kodu / Product Code	35020
Kalınlık / Thickness	2 mm
Ağırlık / Weight	1,285 kg/m 2,833 lb/m

Ürün Kodu / Product Code	35019
Kalınlık / Thickness	1,8 mm
Ağırlık / Weight	1,317 kg/m 2,9035 lb/m

Ürün Kodu / Product Code	35023
Kalınlık / Thickness	1,1 mm
Ağırlık / Weight	0,332 kg/m 0,732 lb/m

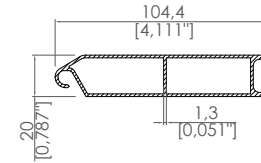
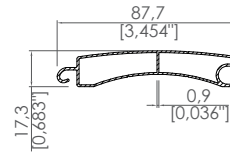
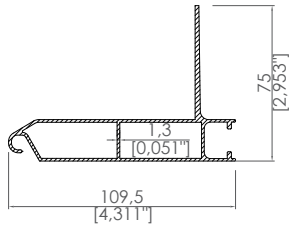

Ürün Kodu / Product Code	35026
Kalınlık / Thickness	1,3 mm
Ağırlık / Weight	1,321 kg/m 2,9123 lb/m

Ürün Kodu / Product Code	35022
Kalınlık / Thickness	0,9 mm
Ağırlık / Weight	0,584 kg/m 1,2875 lb/m

Ürün Kodu / Product Code	35021
Kalınlık / Thickness	1,3 mm
Ağırlık / Weight	0,973 kg/m 2,145 lb/m

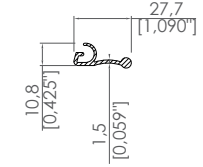
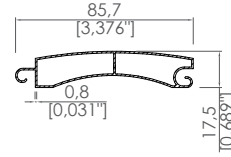
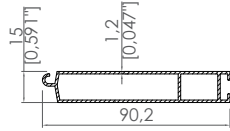

Ürün Kodu / Product Code	35018
Kalınlık / Thickness	1,2 mm
Ağırlık / Weight	0,720 kg/m 1,5873 lb/m

Ürün Kodu / Product Code	35017
Kalınlık / Thickness	0,8 mm
Ağırlık / Weight	0,480 kg/m 1,0582 lb/m

Ürün Kodu / Product Code	3103
Kalınlık / Thickness	1,5 mm
Ağırlık / Weight	0,214 kg/m 0,4718 lb/m

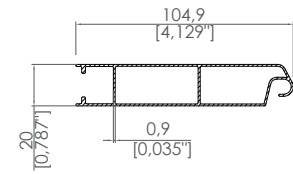
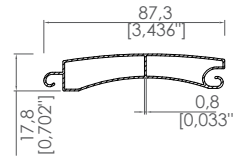
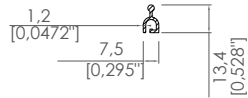

Ürün Kodu / Product Code	3102
Kalınlık / Thickness	1,2 mm
Ağırlık / Weight	0,098 kg/m 0,21605 lb/m

Ürün Kodu / Product Code	3477
Kalınlık / Thickness	0,8 mm
Ağırlık / Weight	0,526 kg/m 1,1596 lb/m

Ürün Kodu / Product Code	3199
Kalınlık / Thickness	0,9 mm
Ağırlık / Weight	0,705 kg/m 1,5543 lb/m

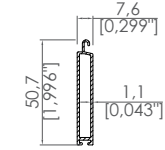
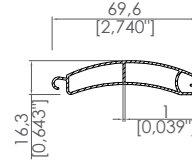
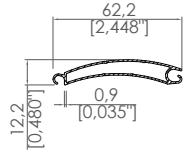

Ürün Kodu / Product Code	3105
Kalınlık / Thickness	0,9 mm
Ağırlık / Weight	0,317 kg/m 0,6989 lb/m

Ürün Kodu / Product Code	3104
Kalınlık / Thickness	1 mm
Ağırlık / Weight	0,469 kg/m 1,034 lb/m

Ürün Kodu / Product Code	2645
Kalınlık / Thickness	1,1 mm
Ağırlık / Weight	0,328 kg/m 0,7231 lb/m

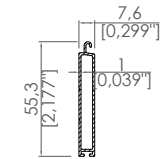
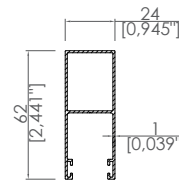
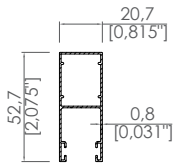

Ürün Kodu / Product Code	2501
Kalınlık / Thickness	0,8 mm
Ağırlık / Weight	0,366 kg/m 0,8069 lb/m

Ürün Kodu / Product Code	2500
Kalınlık / Thickness	1 mm
Ağırlık / Weight	0,505 kg/m 1,1133 lb/m

Ürün Kodu / Product Code	2498
Kalınlık / Thickness	1 mm
Ağırlık / Weight	0,331 kg/m 0,7297 lb/m

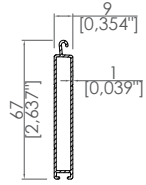

Ürün Kodu / Product Code	2497
Kalınlık / Thickness	1 mm
Ağırlık / Weight	0,402 kg/m 0,8863 lb/m

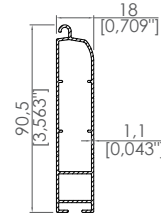

Ürün Kodu / Product Code	2444
Kalınlık / Thickness	1,1 mm
Ağırlık / Weight	0,716 kg/m 1,5785 lb/m

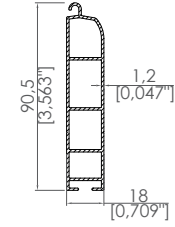

Ürün Kodu / Product Code	2199
Kalınlık / Thickness	1,2 mm
Ağırlık / Weight	0,851 kg/m 1,876 lb/m

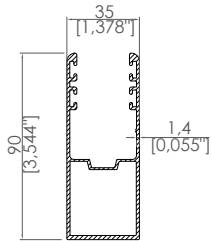

Ürün Kodu / Product Code	2652
Kalınlık / Thickness	1,4 mm
Ağırlık / Weight	1,177 kg/m 2,595 lb/m

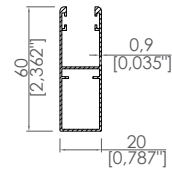

Ürün Kodu / Product Code	2651
Kalınlık / Thickness	0,9 mm
Ağırlık / Weight	0,456 kg/m 1,0053 lb/m

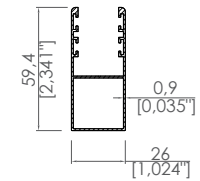

Ürün Kodu / Product Code	2650
Kalınlık / Thickness	0,9 mm
Ağırlık / Weight	0,518 kg/m 1,142 lb/m

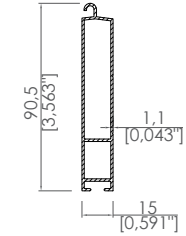
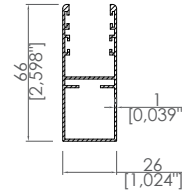
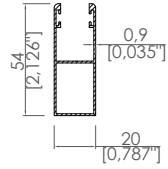

Ürün Kodu / Product Code	2649
Kalınlık / Thickness	0,9 mm
Ağırlık / Weight	0,412 kg/m 0,9083 lb/m

Ürün Kodu / Product Code	2648
Kalınlık / Thickness	1 mm
Ağırlık / Weight	0,632 kg/m 1,3933 lb/m

Ürün Kodu / Product Code	2647
Kalınlık / Thickness	1,1 mm
Ağırlık / Weight	0,675 kg/m 1,488 lb/m

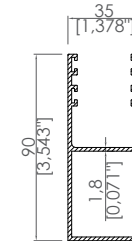
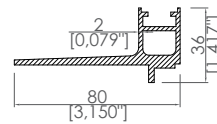
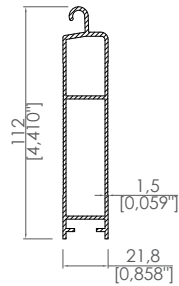

Ürün Kodu / Product Code	2646
Kalınlık / Thickness	1,5 mm
Ağırlık / Weight	1,136 kg/m 2,5045 lb/m

Ürün Kodu / Product Code	35020
Kalınlık / Thickness	2 mm
Ağırlık / Weight	1,285 kg/m 2,833 lb/m

Ürün Kodu / Product Code	35019
Kalınlık / Thickness	1,8 mm
Ağırlık / Weight	1,317 kg/m 2,9035 lb/m

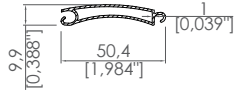

Ürün Kodu / Product Code	3337
Kalınlık / Thickness	1 mm
Ağırlık / Weight	0,314 kg/m 0,6923 lb/m

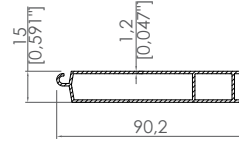

Ürün Kodu / Product Code	35018
Kalınlık / Thickness	1,2 mm
Ağırlık / Weight	0,720 kg/m 1,5873 lb/m

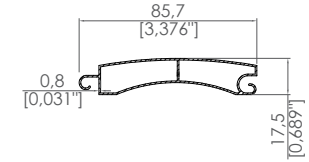

Ürün Kodu / Product Code	35017
Kalınlık / Thickness	0,8 mm
Ağırlık / Weight	0,480 kg/m 1,0582 lb/m

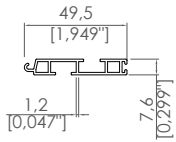

Ürün Kodu / Product Code	3372
Kalınlık / Thickness	1,2 mm
Ağırlık / Weight	0,350 kg/m 0,7716 lb/m

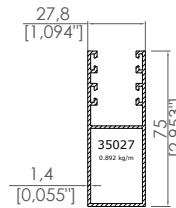

Ürün Kodu / Product Code	35027
Kalınlık / Thickness	1,4 mm
Ağırlık / Weight	0,892 kg/m 1,9665 lb/m

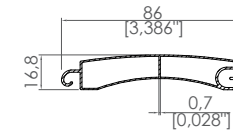

Ürün Kodu / Product Code	35027
Kalınlık / Thickness	0,7 mm
Ağırlık / Weight	0,470 kg/m 1,0362 lb/m

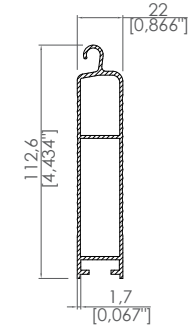
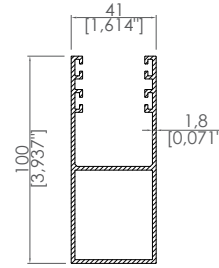
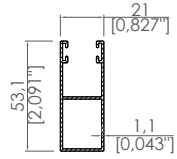

Ürün Kodu / Product Code	35024
Kalınlık / Thickness	1,1 mm
Ağırlık / Weight	1,703 kg/m 3,7545 lb/m

Ürün Kodu / Product Code	2197
Kalınlık / Thickness	1,8 mm
Ağırlık / Weight	1,537 kg/m 3,3885 lb/m

Ürün Kodu / Product Code	2196
Kalınlık / Thickness	1,7 mm
Ağırlık / Weight	1,133 kg/m 2,4537 lb/m

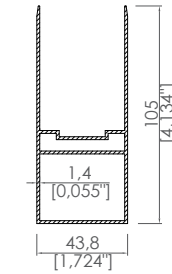
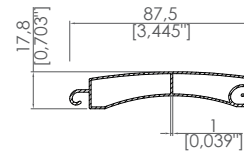
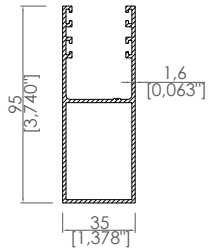

Ürün Kodu / Product Code	2140
Kalınlık / Thickness	1,6 mm
Ağırlık / Weight	1,244 kg/m 2,7426 lb/m

Ürün Kodu / Product Code	37076
Kalınlık / Thickness	1 mm
Ağırlık / Weight	0,569 kg/m 1,2544 lb/m

Ürün Kodu / Product Code	37052
Kalınlık / Thickness	1,4 mm
Ağırlık / Weight	1,276 kg/m 2,813 lb/m

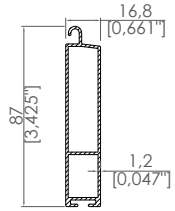

Ürün Kodu / Product Code	2143
Kalınlık / Thickness	1,2 mm
Ağırlık / Weight	0,734 kg/m 1,6182 lb/m

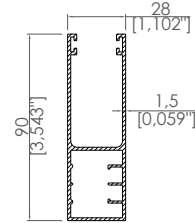

Ürün Kodu / Product Code	2142
Kalınlık / Thickness	1,5 mm
Ağırlık / Weight	1,070 kg/m 2,359 lb/m

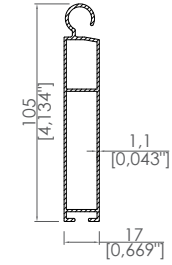

Ürün Kodu / Product Code	35028
Kalınlık / Thickness	1,1 mm
Ağırlık / Weight	0,829 kg/m 1,8276 lb/m

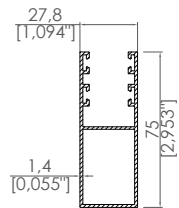

Ürün Kodu / Product Code	35027
Kalınlık / Thickness	1,4 mm
Ağırlık / Weight	0,892 kg/m 1,9665 lb/m

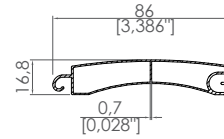

Ürün Kodu / Product Code	35025
Kalınlık / Thickness	0,7 mm
Ağırlık / Weight	0,470 kg/m 1,0362 lb/m

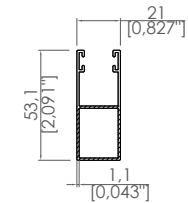

Ürün Kodu / Product Code	35024
Kalınlık / Thickness	1,1 mm
Ağırlık / Weight	1,703 kg/m 3,7545 lb/m

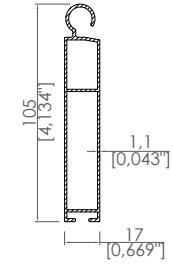

Ürün Kodu / Product Code	35028
Kalınlık / Thickness	1,1 mm
Ağırlık / Weight	0,829 kg/m 1,8276 lb/m

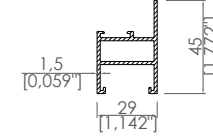

Ürün Kodu / Product Code	3120
Kalınlık / Thickness	1,5 mm
Ağırlık / Weight	0,566 kg/m 1,2478 lb/m

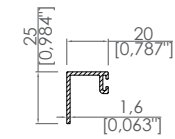
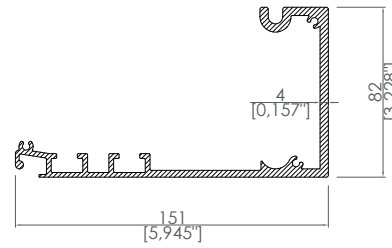
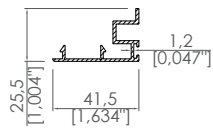

Ürün Kodu / Product Code	3121
Kalınlık / Thickness	1,2 mm
Ağırlık / Weight	0,371 kg/m 0,8179 lb/m

Ürün Kodu / Product Code	3114
Kalınlık / Thickness	4 mm
Ağırlık / Weight	3,054 kg/m 6,733 lb/m

Ürün Kodu / Product Code	3119
Kalınlık / Thickness	1,6 mm
Ağırlık / Weight	0,244 kg/m 0,5379 lb/m

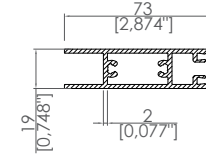
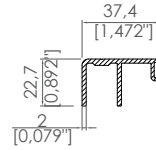
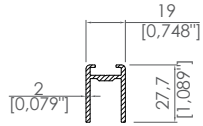

Ürün Kodu / Product Code	3118
Kalınlık / Thickness	2 mm
Ağırlık / Weight	0,398 kg/m 0,8774 lb/m

Ürün Kodu / Product Code	3117
Kalınlık / Thickness	2 mm
Ağırlık / Weight	0,496 kg/m 1,0935 lb/m

Ürün Kodu / Product Code	3116
Kalınlık / Thickness	2 mm
Ağırlık / Weight	1,108 kg/m 2,4427 lb/m

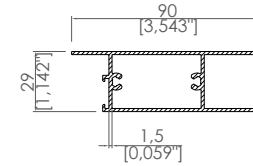
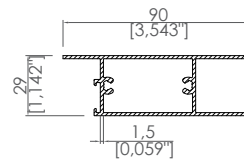
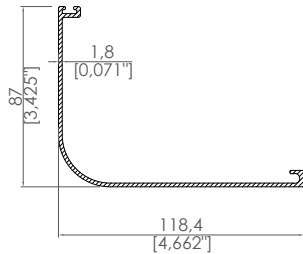

Ürün Kodu / Product Code	3115
Kalınlık / Thickness	1,8 mm
Ağırlık / Weight	1,070 kg/m 2,359 lb/m

Ürün Kodu / Product Code	3123
Kalınlık / Thickness	1,5 mm
Ağırlık / Weight	1,068 kg/m 2,3545 lb/m

Ürün Kodu / Product Code	3122
Kalınlık / Thickness	1,5 mm
Ağırlık / Weight	1,008 kg/m 2,2223 lb/m

**TENTE PROFİLLERİ**  
AWNING PROFILES



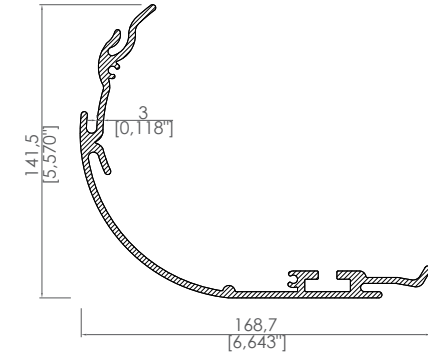
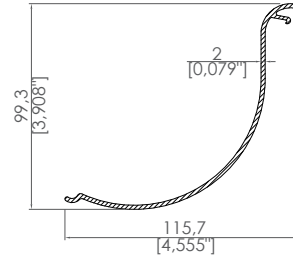
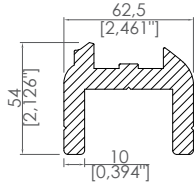

Ürün Kodu / Product Code	4366
Kalınlık / Thickness	10 mm
Ağırlık / Weight	3,875 kg/m 8,5429 lb/m

Ürün Kodu / Product Code	4368
Kalınlık / Thickness	2 mm
Ağırlık / Weight	1,035 kg/m 2,2817 lb/m

Ürün Kodu / Product Code	4370
Kalınlık / Thickness	3 mm
Ağırlık / Weight	3,512 kg/m 7,9454 lb/m

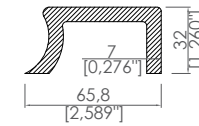
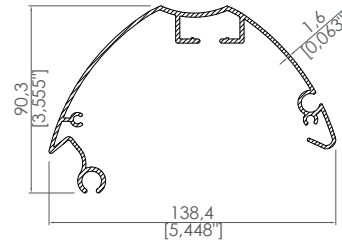
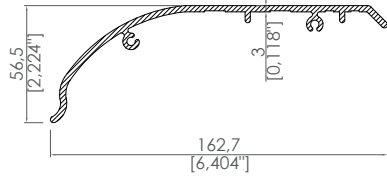

Ürün Kodu / Product Code	4367
Kalınlık / Thickness	3 mm
Ağırlık / Weight	1,797 kg/m 3,9595 lb/m

Ürün Kodu / Product Code	4369
Kalınlık / Thickness	1,6 mm
Ağırlık / Weight	1,735 kg/m 3,825 lb/m

Ürün Kodu / Product Code	4373
Kalınlık / Thickness	7 mm
Ağırlık / Weight	0,406 kg/m 0,895 lb/m

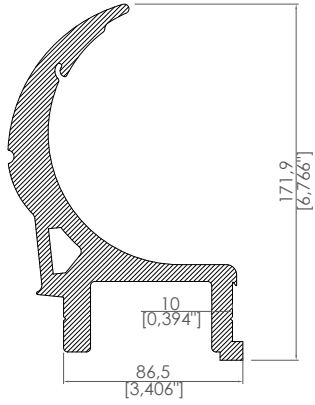

Ürün Kodu / Product Code	4371
Kalınlık / Thickness	10 mm
Ağırlık / Weight	10,975 kg/m 24,196 lb/m

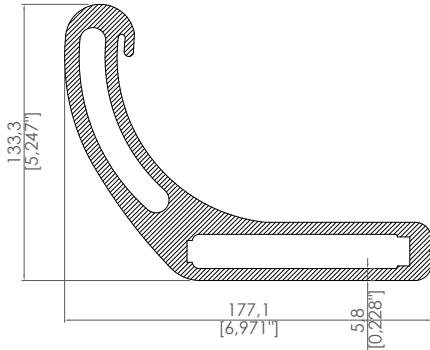

Ürün Kodu / Product Code	4372
Kalınlık / Thickness	5,8 mm
Ağırlık / Weight	10,731 kg/m 23,657 lb/m







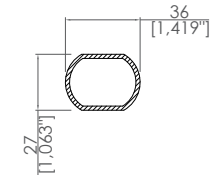
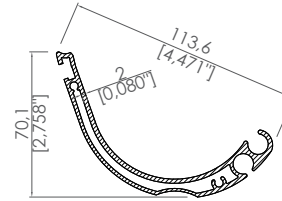

Ürün Kodu / Product Code	6244
Kalınlık / Thickness	2 mm
Ağırlık / Weight	1,645 kg/m 3,6376 lb/m

Ürün Kodu / Product Code	6246
Kalınlık / Thickness	2 mm
Ağırlık / Weight	0,542 kg/m 1,195 lb/m

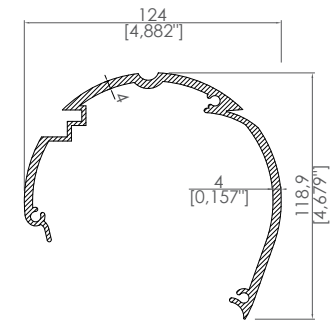
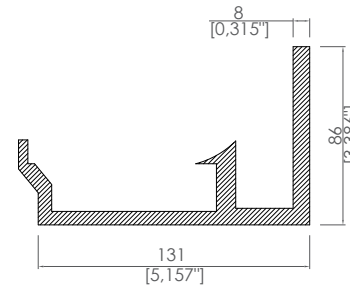

Ürün Kodu / Product Code	6312
Kalınlık / Thickness	8 mm
Ağırlık / Weight	5,596 kg/m 12,337 lb/m

Ürün Kodu / Product Code	6245
Kalınlık / Thickness	4 mm
Ağırlık / Weight	3,060 kg/m 6,746 lb/m

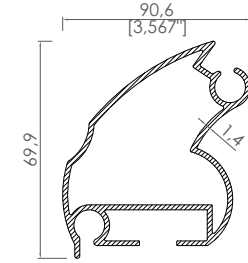
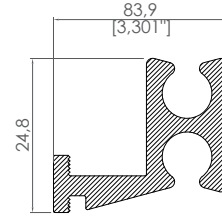
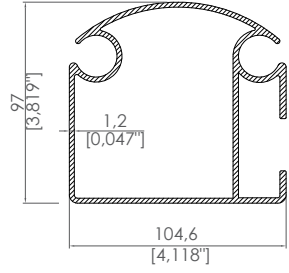

Ürün Kodu / Product Code	5315
Kalınlık / Thickness	1,2 mm
Ağırlık / Weight	0,811 kg/m 1,788 lb/m

Ürün Kodu / Product Code	5385
Kalınlık / Thickness	3,2 mm
Ağırlık / Weight	0,623 kg/m 1,373 lb/m

Ürün Kodu / Product Code	5465
Kalınlık / Thickness	1,4 mm
Ağırlık / Weight	1,150 kg/m 2,5353 lb/m



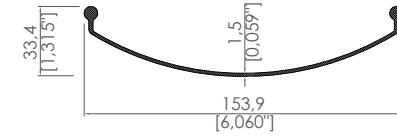
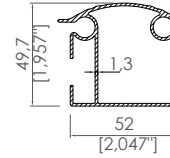
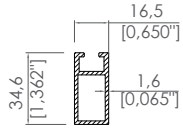

Ürün Kodu / Product Code	37093
Kalınlık / Thickness	1,6 mm
Ağırlık / Weight	0,488 kg/m 1,0759 lb/m

Ürün Kodu / Product Code	0040
Kalınlık / Thickness	1,3 mm
Ağırlık / Weight	0,925 kg/m 2,0393 lb/m

Ürün Kodu / Product Code	5386
Kalınlık / Thickness	1,5 mm
Ağırlık / Weight	0,872 kg/m 1,9224 lb/m

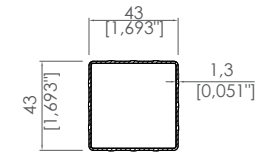
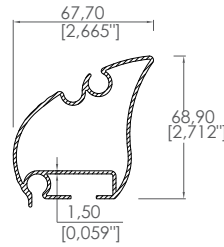
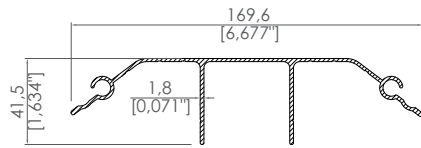

Ürün Kodu / Product Code	1887
Kalınlık / Thickness	1,8 mm
Ağırlık / Weight	1,314 kg/m 2,897 lb/m

Ürün Kodu / Product Code	0041
Kalınlık / Thickness	1,5 mm
Ağırlık / Weight	1,269 kg/m 2,7977 lb/m

Ürün Kodu / Product Code	0039
Kalınlık / Thickness	1,3mm
Ağırlık / Weight	0,475 kg/m 1,0472 lb/m

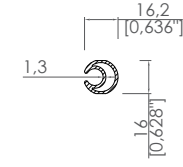
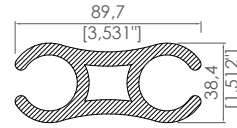
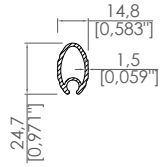

Ürün Kodu / Product Code	0042
Kalınlık / Thickness	1,5 mm
Ağırlık / Weight	0,281 kg/m 0,6195 lb/m

Ürün Kodu / Product Code	37184
Kalınlık / Thickness	6,9 mm
Ağırlık / Weight	0,425 kg/m 0,937 lb/m

Ürün Kodu / Product Code	5377
Kalınlık / Thickness	1,3 mm
Ağırlık / Weight	0,228 kg/m 0,5027 lb/m

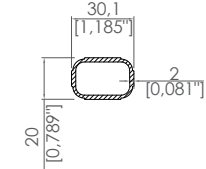
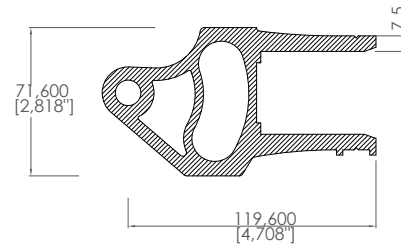
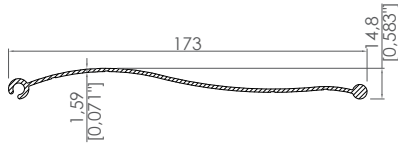

Ürün Kodu / Product Code	1888
Kalınlık / Thickness	1,59 mm
Ağırlık / Weight	0,903 kg/m 1,9908 lb/m

Ürün Kodu / Product Code	0080
Kalınlık / Thickness	7,5 mm
Ağırlık / Weight	7,433 kg/m 16,387 lb/m

Ürün Kodu / Product Code	0053
Kalınlık / Thickness	2 mm
Ağırlık / Weight	0,396 kg/m 0,873 lb/m

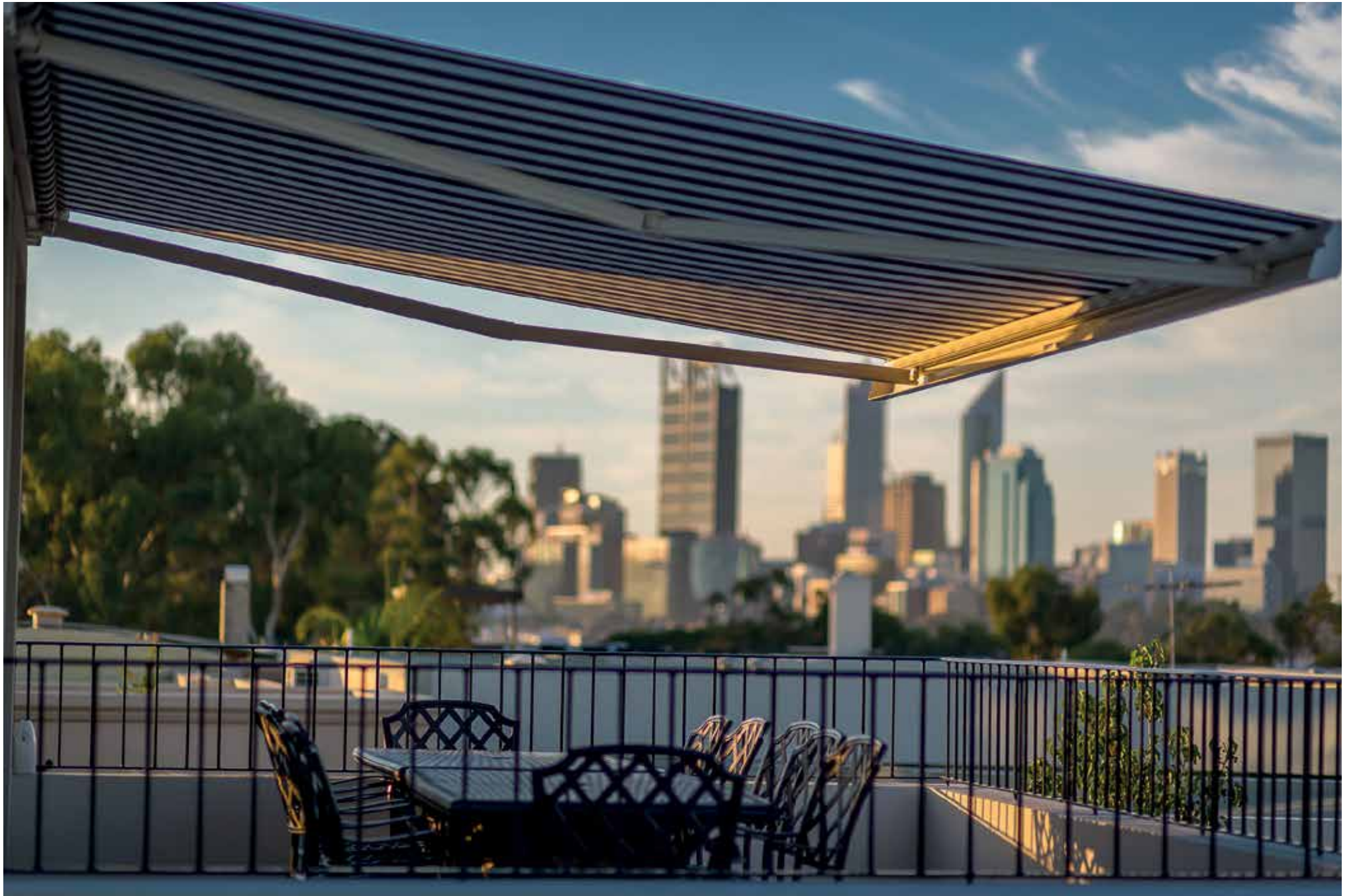



**Architecture** profile systems



**PERGOLA SİSTEMLERİ**  
PERGOLA SYSTEMS

**Hittit Egimli ve Oval Pergola Sistemleri**  
Hittite Inclined and Curved Pergola Systems



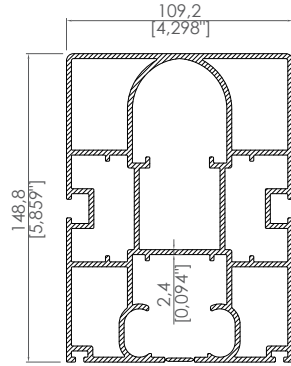

**110x150 Ray**  
110x150 Rail Profile

Ürün Kodu / Product Code	2001
Kalınlık / Thickness	2,4 mm
Ağırlık / Weight	7,168 kg/m 15,803 lb/m

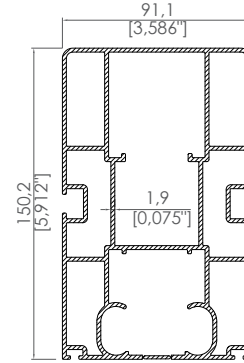

**90x150 Ray**  
90x150 Rail Profile

Ürün Kodu / Product Code	2052
Kalınlık / Thickness	1,9 mm
Ağırlık / Weight	5,217 kg/m 11,502 lb/m

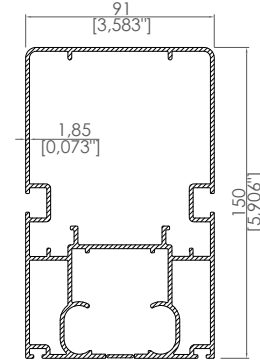

**90x150 Eko Ray**  
90x150 Eco Rail Profile

Ürün Kodu / Product Code	2932
Kalınlık / Thickness	1,85 mm
Ağırlık / Weight	3,984 kg/m 8,783 lb/m

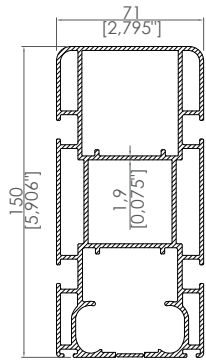

**70x150 Ray**  
70x150 Rail Profile

Ürün Kodu / Product Code	6413
Kalınlık / Thickness	1,9 mm
Ağırlık / Weight	4,655 kg/m 10,263 lb/m

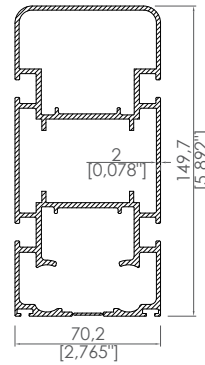

**70x150 Ray**  
70x150 Rail Profile

Ürün Kodu / Product Code	5922
Kalınlık / Thickness	2 mm
Ağırlık / Weight	4,212 kg/m 9,286 lb/m

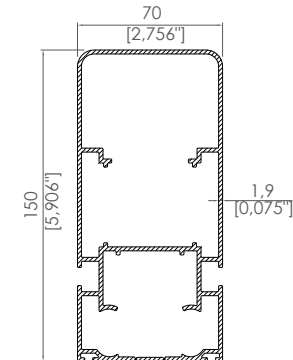

**70x150 Eko Ray**  
70x150 Eco Rail Profile

Ürün Kodu / Product Code	2156
Kalınlık / Thickness	1,9 mm
Ağırlık / Weight	3,217 kg/m 7,092 lb/m

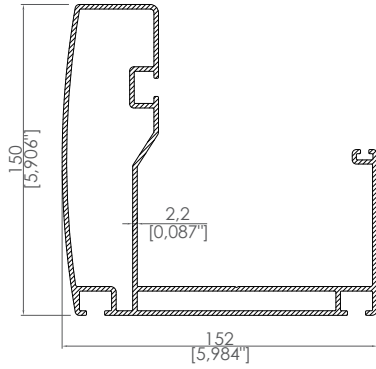

152x150 Dere  
152X150 Gutter

Ürün Kodu / Product Code	2078
Kalınlık / Thickness	2,2 mm
Ağırlık / Weight	4,398 kg/m 9,696 lb/m

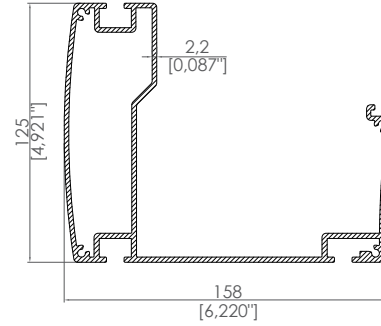

158X125 Dere  
158X125 Gutter

Ürün Kodu / Product Code	5935
Kalınlık / Thickness	2,2 mm
Ağırlık / Weight	3,916 kg/m 8,633 lb/m

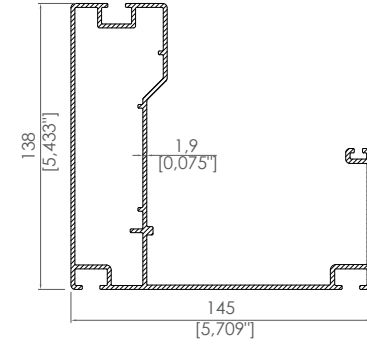

138x145 Eko Dere  
138X145 Eco Gutter

Ürün Kodu / Product Code	3263
Kalınlık / Thickness	1,9 mm
Ağırlık / Weight	3,320 kg/m 7,32 lb/m

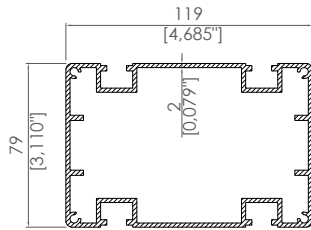

Yatay Profil  
Side Profile

Ürün Kodu / Product Code	5936
Kalınlık / Thickness	2 mm
Ağırlık / Weight	3,032 kg/m 6,684 lb/m

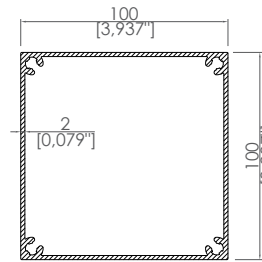

100x100 Dikme  
100x100 Pillar

Ürün Kodu / Product Code	6565
Kalınlık / Thickness	2 mm
Ağırlık / Weight	2,463 kg/m 5,43 lb/m

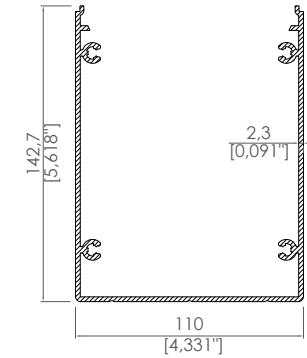

110x145 Dikme Gövde  
110x145 Pillar Main Profile

Ürün Kodu / Product Code	2301
Kalınlık / Thickness	2,3 mm
Ağırlık / Weight	3,003 kg/m 6,62 lb/m

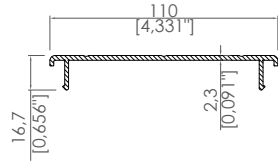

**110x145 Dikme Kapak**  
110x145 Pillar Cover Profile

Ürün Kodu / Product Code	2302
Kalınlık / Thickness	2,3 mm
Ağırlık / Weight	0,846 kg/m 1,865 lb/m

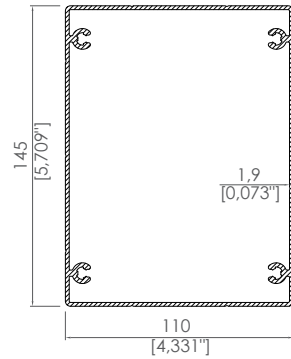

**110x145 Dikme**  
110x145 Pillar

Ürün Kodu / Product Code	2111
Kalınlık / Thickness	1,9 mm
Ağırlık / Weight	3,044 kg/m 6,711 lb/m

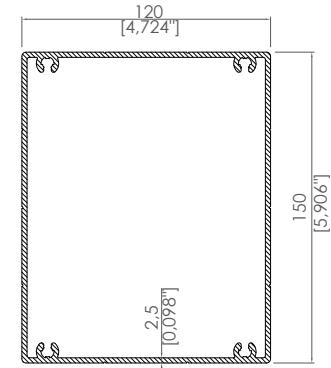

**120x150 Dikme**  
120x150 Pillar

Ürün Kodu / Product Code	6569
Kalınlık / Thickness	2,5 mm
Ağırlık / Weight	3,994 kg/m 8,805 lb/m

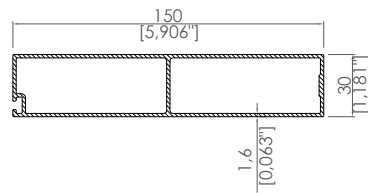

**30x150 Kutu Profil**  
30x150 Box Profile

Ürün Kodu / Product Code	37025
Kalınlık / Thickness	1,6 mm
Ağırlık / Weight	1,711 kg/m 3,785 lb/m

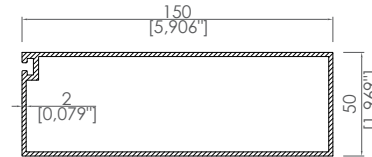

**50x150 Kutu Profil**  
50x150 Box Profile

Ürün Kodu / Product Code	1517
Kalınlık / Thickness	2 mm
Ağırlık / Weight	2,217 kg/m 4,888 lb/m

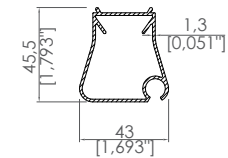

**43x45,5 Kumaş Profili**  
43x45,5 Fabric Support Profile

Ürün Kodu / Product Code	3370
Kalınlık / Thickness	1,3 mm
Ağırlık / Weight	0,667 kg/m 1,4705 lb/m

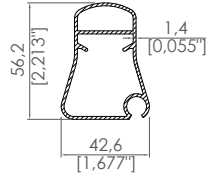

42,6x56,2 Kumaş Profili  
42,6x56,2 Fabric Support Profile

Ürün Kodu / Product Code	37156
Kalınlık / Thickness	1,4 mm
Ağırlık / Weight	0,845 kg/m 1,863 lb/m

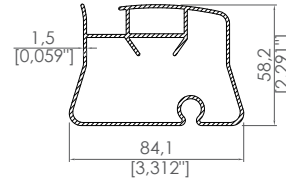

84,1x58,2 Kumaş Profili  
84,1x58,2 Fabric Support Profile

Ürün Kodu / Product Code	37200
Kalınlık / Thickness	1,5 mm
Ağırlık / Weight	1,510 kg/m 3,329 lb/m

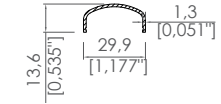

Kumaş Profili Kapağı  
Fabric Support Profile Cover

Ürün Kodu / Product Code	37034
Kalınlık / Thickness	1,3 mm
Ağırlık / Weight	0,163 kg/m 0,35935 lb/m

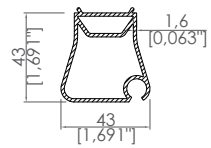

43x43 Kumaş Profili  
43x43 Fabric Support Profile

Ürün Kodu / Product Code	37033
Kalınlık / Thickness	1,6 mm
Ağırlık / Weight	0,882 kg/m 1,9445 lb/m

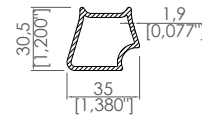

35x30,5 Kumaş Profili Eki  
35x30,5 Fabric Support Connection Profile

Ürün Kodu / Product Code	5477
Kalınlık / Thickness	1,9 mm
Ağırlık / Weight	0,616 kg/m 1,358 lb/m

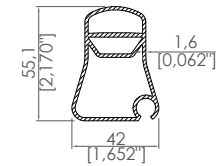

42x55,1 Kumaş Profili  
42x55,1 Fabric Support Profile

Ürün Kodu / Product Code	5261
Kalınlık / Thickness	1,6 mm
Ağırlık / Weight	1,100 kg/m 2,425 lb/m

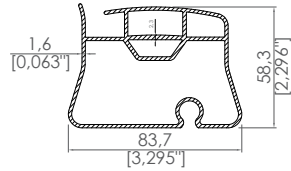

**83,7x58,3 Kumaş Profili**  
83,7x58,3 Fabric Support Profile

Ürün Kodu / Product Code	5410
Kalınlık / Thickness	1,6 mm
Ağırlık / Weight	1,830 kg/m 4,0345 lb/m

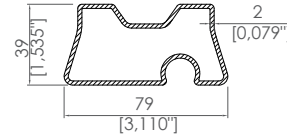

**79x39 Kumaş Profili Eki**  
79x39 Fabric Support Profile Connection

Ürün Kodu / Product Code	5478
Kalınlık / Thickness	2 mm
Ağırlık / Weight	1,309 kg/m 2,886 lb/m

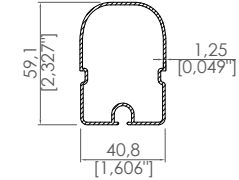

**40,8x59,1 Kumaş Profili**  
40,8x59,1 Fabric Support Profile

Ürün Kodu / Product Code	2653
Kalınlık / Thickness	1,2 mm
Ağırlık / Weight	0,697 kg/m 1,5366 lb/m

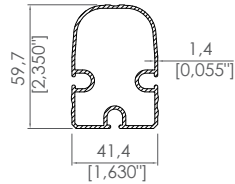

**41,4x 59,7 Kumaş Profili**  
41,4x 59,7 Fabric Support Profile

Ürün Kodu / Product Code	37153
Kalınlık / Thickness	1,4 mm
Ağırlık / Weight	0,937 kg/m 2,0657 lb/m

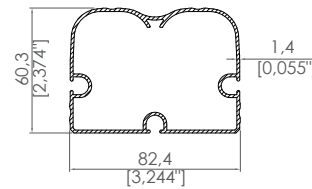

**82,4x60,3 Kumaş Profili**  
82,4x60,3 Fabric Support Profile

Ürün Kodu / Product Code	37216
Kalınlık / Thickness	1,4 mm
Ağırlık / Weight	1,280 kg/m 2,822 lb/m

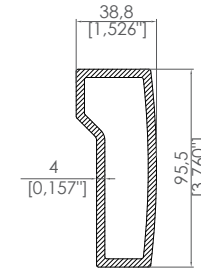

**38,8x95,5 Dere Eki Profili**  
38,8x95,5 Gutter Profile Connection

Ürün Kodu / Product Code	6536
Kalınlık / Thickness	4 mm
Ağırlık / Weight	2,618 kg/m 5,772 lb/m

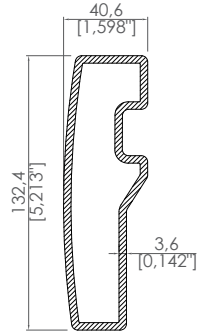

40,6X132,4 Dere Eki Profili  
40,6X132,4 Gutter Profile Connection

Ürün Kodu / Product Code	2281
Kalınlık / Thickness	3,6 mm
Ağırlık / Weight	3,246 kg/m 7,156 lb/m

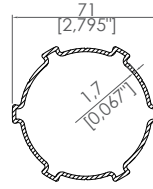

Motor Borusu Eki  
Motor Tube Connection

Ürün Kodu / Product Code	37100
Kalınlık / Thickness	1,7 mm
Ağırlık / Weight	1,074 kg/m 2,368 lb/m

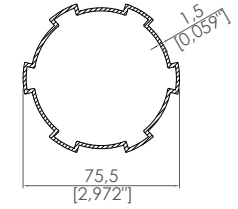

Motor Borusu  
Motor Tube

Ürün Kodu / Product Code	5312
Kalınlık / Thickness	1,5 mm
Ağırlık / Weight	1,100 kg/m 2,425 lb/m





**BİOKLİMATİK SİSTEMLERİ**  
BIOCLIMATIC SYSTEMS

**Sümer Bioklimatik**  
Sumer Bioclimatic



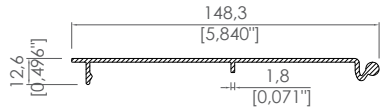

**Motor Kutusu Kapağı**  
Motor Box Cover

Ürün Kodu / Product Code	2091
Kalınlık / Thickness	1,8 mm
Ağırlık / Weight	0,915 kg/m 2,0172 lb/m

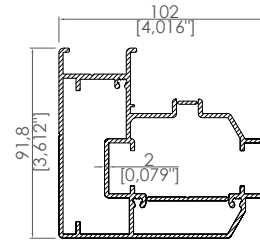

**Ray Profili**  
Rail Profile

Ürün Kodu / Product Code	2279
Kalınlık / Thickness	2 mm
Ağırlık / Weight	3,056 kg/m 6,737 lb/m

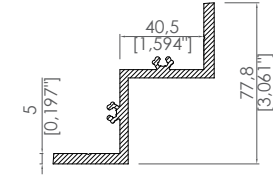

**Köşe Birleştirici**  
Corner Connection Bracket

Ürün Kodu / Product Code	2119
Kalınlık / Thickness	5 mm
Ağırlık / Weight	1,987 kg/m 4,381 lb/m

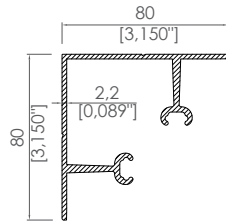

**Köşe Birleştirici Kapağı**  
Corner Connection Cover

Ürün Kodu / Product Code	2118
Kalınlık / Thickness	2,2 mm
Ağırlık / Weight	1,692 kg/m 3,73 lb/m

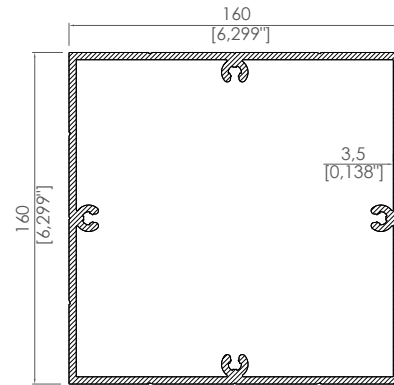

**Çizgili Dikme Profili**  
Lined Pillar Profile

Ürün Kodu / Product Code	2087
Kalınlık / Thickness	3,5 mm
Ağırlık / Weight	6,822 kg/m 15,04 lb/m

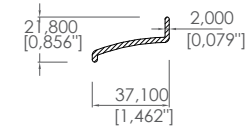

**Motor Kutusu Ön Profil**  
Motor Box Front Profile

Ürün Kodu / Product Code	2092
Kalınlık / Thickness	2 mm
Ağırlık / Weight	0,326 kg/m 0,7187 lb/m

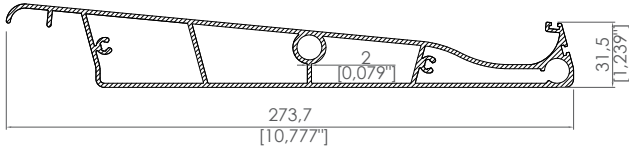

Panel Profili  
Panel Profile

Ürün Kodu / Product Code	2096
Kalınlık / Thickness	2 mm
Ağırlık / Weight	3,962 kg/m 8,735 lb/m

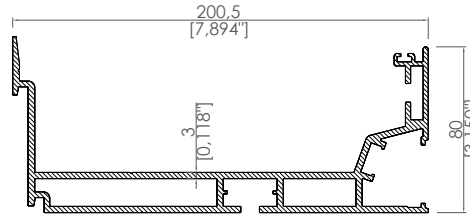

Dere Profil  
Gutter Profile

Ürün Kodu / Product Code	2089
Kalınlık / Thickness	3 mm
Ağırlık / Weight	4,950 kg/m 10,913 lb/m

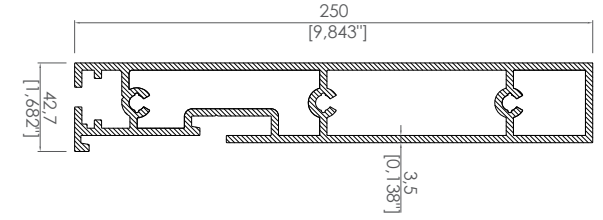

Yan Kayıt Profili  
Side Beam Profile

Ürün Kodu / Product Code	2088
Kalınlık / Thickness	3,5 mm
Ağırlık / Weight	7,213 kg/m 15,902 lb/m

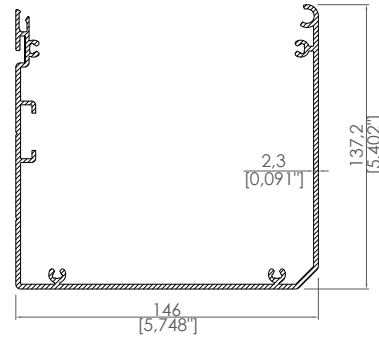

Motor Kutusu  
Motor Box

Ürün Kodu / Product Code	2090
Kalınlık / Thickness	2,3 mm
Ağırlık / Weight	3,075 kg/m 6,779 lb/m

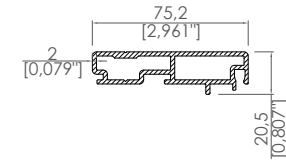

Ray Kapak Profili  
Rail Cover Profile

Ürün Kodu / Product Code	2280
Kalınlık / Thickness	2 mm
Ağırlık / Weight	1,150 kg/m 2,5353 lb/m



**BIOKLİMATİK SİSTEMLERİ**  
BIOCLIMATIC SYSTEMS

**Frigya Bioklimatik**  
Phrygia Bioclimatic



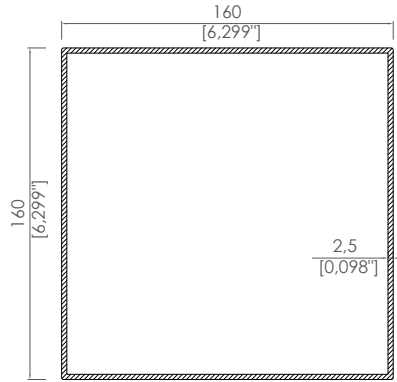

**Dikme Profili**  
Pillar Profile

Ürün Kodu / Product Code	2426
Kalınlık / Thickness	2,5 mm
Ağırlık / Weight	4,270 kg/m 9,414 lb/m

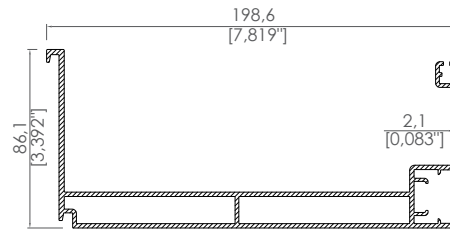

**Dere Profili**  
Gutter Profile

Ürün Kodu / Product Code	2423
Kalınlık / Thickness	2,1 mm
Ağırlık / Weight	3,512 kg/m 7,743 lb/m

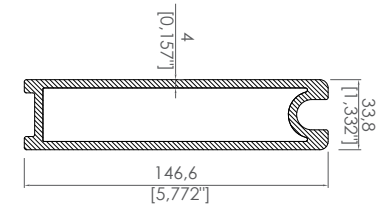

**Yan Kayıt Bağlantı Profili**  
Side Beam Connection Profile

Ürün Kodu / Product Code	2425
Kalınlık / Thickness	4 mm
Ağırlık / Weight	4,082 kg/m 9 lb/m

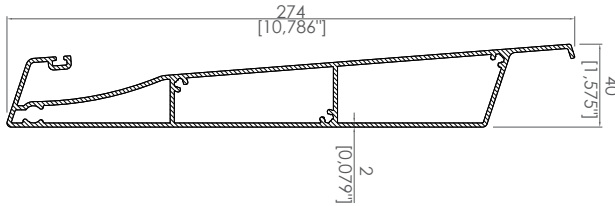

**Panel Profili**  
Panel Profile

Ürün Kodu / Product Code	2420
Kalınlık / Thickness	2 mm
Ağırlık / Weight	3,700 kg/m 8,157 lb/m

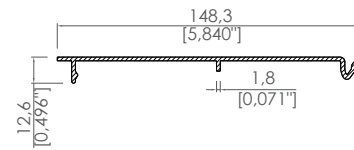

**Motor Kutusu Kapağı**  
Motor Box Cover

Ürün Kodu / Product Code	2091
Kalınlık / Thickness	1,8 mm
Ağırlık / Weight	0,915 kg/m 2,0172 lb/m

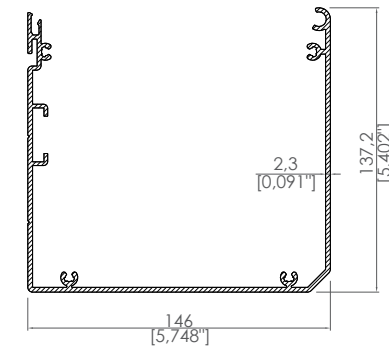

**Motor Kutusu**  
Motor Box

Ürün Kodu / Product Code	2090
Kalınlık / Thickness	2,3 mm
Ağırlık / Weight	3,075 kg/m 6,779 lb/m

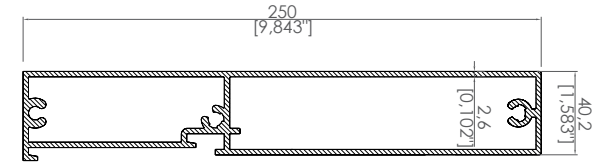
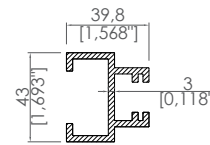
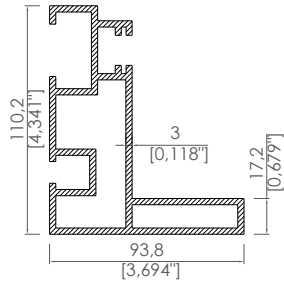

Ray Profili  
Rail Profile

Ürün Kodu / Product Code	2422
Kalınlık / Thickness	3 mm
Ağırlık / Weight	3,933 kg/m 8,67 lb/m

Panel Üst Bağlantı Profili  
Panel Top Connection Profile

Ürün Kodu / Product Code	2421
Kalınlık / Thickness	3 mm
Ağırlık / Weight	1,171 kg/m 2,5816 lb/m

Yan Kayıt Profili  
Side Beam Profile

Ürün Kodu / Product Code	2424
Kalınlık / Thickness	2,6 mm
Ağırlık / Weight	4,990 kg/m 11 lb/m



**BİOKLİMATİK SİSTEMLERİ**  
BIOCLIMATIC SYSTEMS

**Lidya Bioklimatik**  
Lydia Bioclimatic



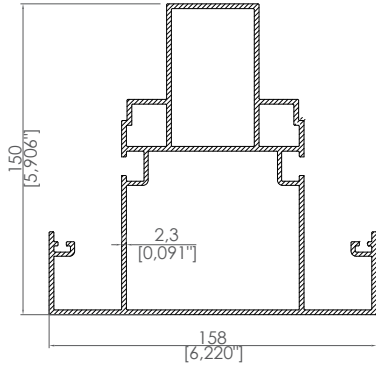

**Orta Taşıyıcı Profili**  
Middle Beam Profile

Ürün Kodu / Product Code	3217
Kalınlık / Thickness	2,3 mm
Ağırlık / Weight	4,943 kg/m 10,897 lb/m

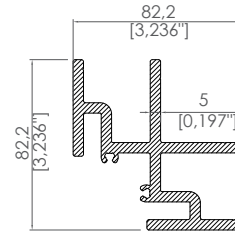

**Köşe Takoz Profili**  
Corner Connection Bracket

Ürün Kodu / Product Code	3222
Kalınlık / Thickness	5 mm
Ağırlık / Weight	3,875 kg/m 8,543 lb/m

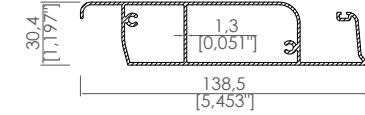

**Panel Profili**  
Panel Profile

Ürün Kodu / Product Code	3224
Kalınlık / Thickness	1,3 mm
Ağırlık / Weight	1,328 kg/m 2,928 lb/m

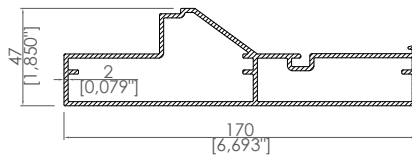

**Yan Taşıyıcı Profili**  
Side Beam Profile

Ürün Kodu / Product Code	3218
Kalınlık / Thickness	2 mm
Ağırlık / Weight	2,558 kg/m 5,639 lb/m

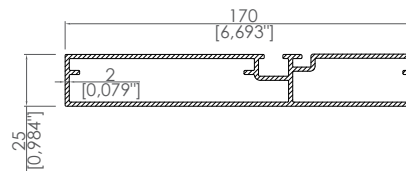

**Ön Taşıyıcı Profili**  
Front Beam Profile

Ürün Kodu / Product Code	3219
Kalınlık / Thickness	2 mm
Ağırlık / Weight	2,434 kg/m 5,366 lb/m

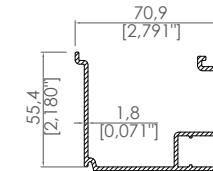

**Dere Profili**  
Gutter Profile

Ürün Kodu / Product Code	3221
Kalınlık / Thickness	1,8 mm
Ağırlık / Weight	1,111 kg/m 2,4493 lb/m

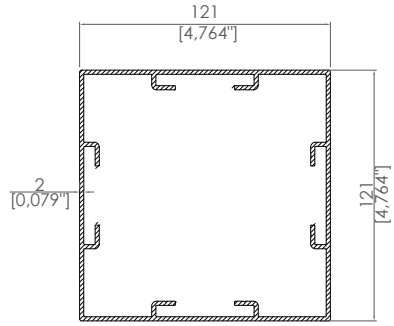

Direk Ayak Profili  
Pillar Profile

Ürün Kodu / Product Code	3220
Kalınlık / Thickness	2 mm
Ağırlık / Weight	3,284 kg/m 7,239 lb/m

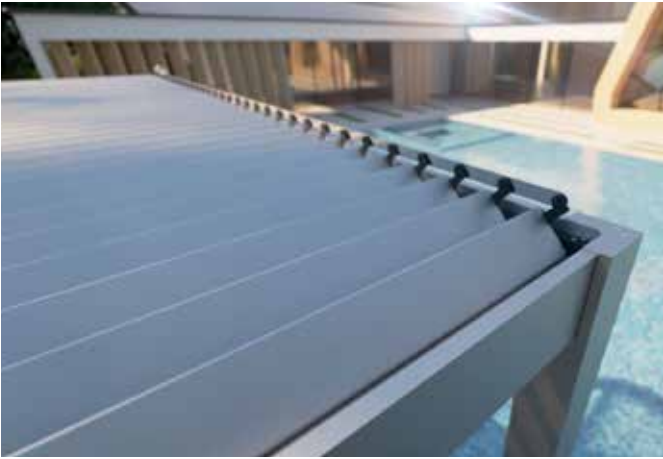



**BİOKLİMATİK SİSTEMLERİ**  
BIOCLIMATIC SYSTEMS

**Cabana Bioklimatik**  
Cabana Bioclimatic



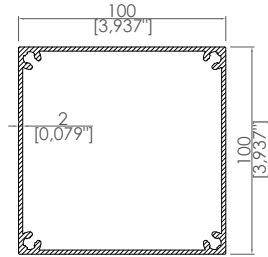

**100x100 Dikme**  
 100x100 Pillar

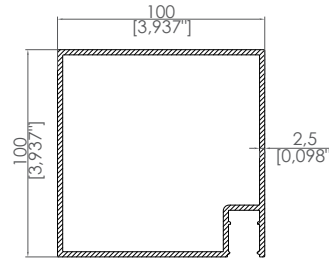
Ürün Kodu / Product Code	6565
Kalınlık / Thickness	2 mm
Ağırlık / Weight	2,463 kg/m 5,43 lb/m

**Kayıt Profili**  
 Beam Profile

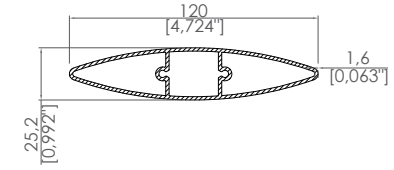
Ürün Kodu / Product Code	3325
Kalınlık / Thickness	2,5 mm
Ağırlık / Weight	2,799 kg/m 6,171 lb/m

**Sun Breaker Profile**  
 Güneş Kırıcı Profili

Ürün Kodu / Product Code	37106
Kalınlık / Thickness	1,6 mm
Ağırlık / Weight	1,325 kg/m 2,921 lb/m

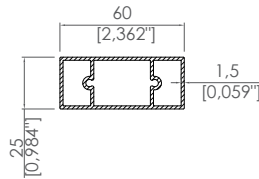
**Kutu Profili**  
 Box Profile

Ürün Kodu / Product Code	3324
Kalınlık / Thickness	1,5 mm
Ağırlık / Weight	0,894 kg/m 1,971 lb/m

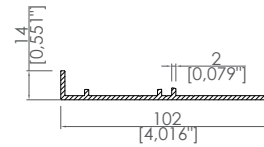
**Panel Kayıt Bağlantı Profili**  
 Panel - Beam Connection Profile

Ürün Kodu / Product Code	3323
Kalınlık / Thickness	2 mm
Ağırlık / Weight	0,686 kg/m 1,5124 lb/m

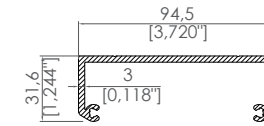

**Kayıt Bağlantı Aparatı**  
 Beam Connection Bracket

Ürün Kodu / Product Code	3322
Kalınlık / Thickness	3 mm
Ağırlık / Weight	3,720 kg/m 8,201 lb/m

**ROLLING ROOF SİSTEMLERİ**  
ROLLING ROOF SYSTEMS

**Luvi Rolling Roof Profilleri**  
Luvian Rolling Roof Profiles

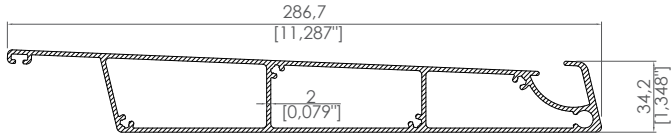



Panel Profili  
Panel Profile

Ürün Kodu / Product Code	2340
Kalınlık / Thickness	2 mm
Ağırlık / Weight	3,986 kg/m 8,788 lb/m

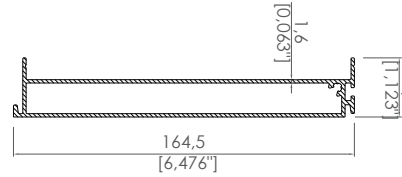

Dere Uzatma Profili  
Gutter Extension Profile

Ürün Kodu / Product Code	2338
Kalınlık / Thickness	1,6 mm
Ağırlık / Weight	1,730 kg/m 3,814 lb/m

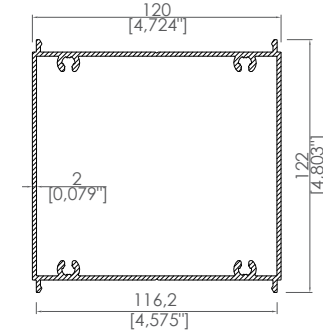

Dikme Profili  
Pillar Profile

Ürün Kodu / Product Code	2341
Kalınlık / Thickness	2 mm
Ağırlık / Weight	3,028 kg/m 6,676 lb/m

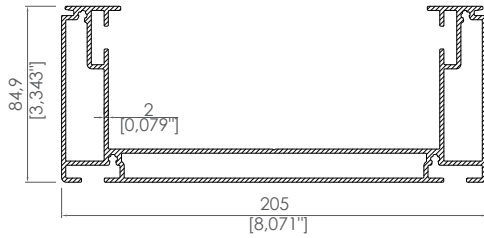

Dere Profili  
Gutter Profile

Ürün Kodu / Product Code	2337
Kalınlık / Thickness	2 mm
Ağırlık / Weight	4,560 kg/m 10,053 lb/m

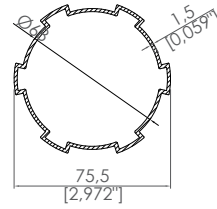

Motor Borusu  
Motor Tube

Ürün Kodu / Product Code	5312
Kalınlık / Thickness	1,5 mm
Ağırlık / Weight	1,100 kg/m 2,425 lb/m

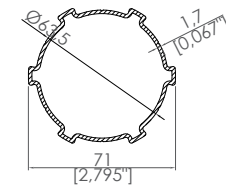

Motor Borusu Eki  
Motor Tube Connection

Ürün Kodu / Product Code	37100
Kalınlık / Thickness	1,7 mm
Ağırlık / Weight	1,074 kg/m 2,368 lb/m

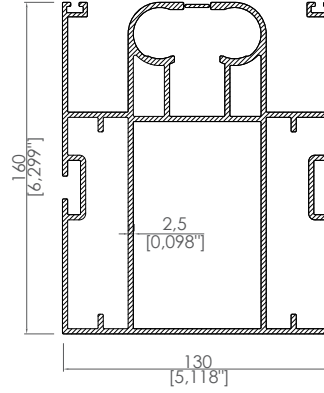

Ray Profili  
Rail Profile

Ürün Kodu / Product Code	2339
Kalınlık / Thickness	2,5 mm
Ağırlık / Weight	7,827 kg/m 17,256 lb/m

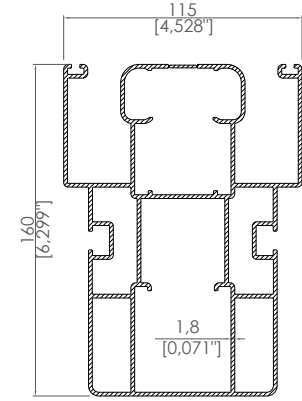

Eko Ray  
Eco Rail Profile

Ürün Kodu / Product Code	2785
Kalınlık / Thickness	1,8 mm
Ağırlık / Weight	5,084 kg/m 11,208 lb/m

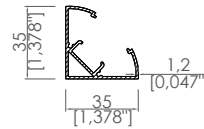

Led Profili  
Led Profile

Ürün Kodu / Product Code	2953
Kalınlık / Thickness	1,2 mm
Ağırlık / Weight	0,445 kg/m 0,981 lb/m

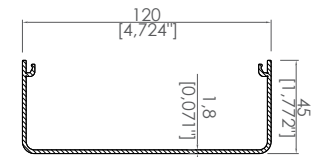

Dikme Kapak Profili  
Pillar Cover Profile

Ürün Kodu / Product Code	2342
Kalınlık / Thickness	1,8 mm
Ağırlık / Weight	1,055 kg/m 2,326 lb/m



**HAREKETLİ VE SABİT  
CAM SİSTEMLERİ**  
MOVABLE AND FIXED GLASS  
CEILING SYSTEMS

**İyonya Veranda Sistemleri**  
Ionian Veranda Systems



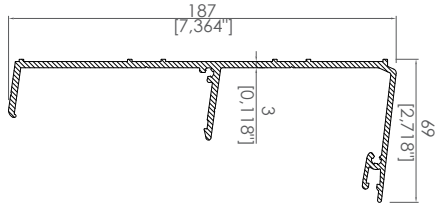

69x187 Arka Kayıt  
69x187 Back Beam

Ürün Kodu / Product Code	2004
Kalınlık / Thickness	3 mm
Ağırlık / Weight	2,602 kg/m 5,736 lb/m

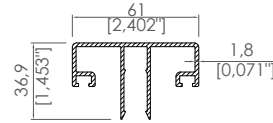

61x36,9 Orta Cam Kapak Profili  
61x36,9 Middle Glass Cover Profile

Ürün Kodu / Product Code	2007
Kalınlık / Thickness	1,8 mm
Ağırlık / Weight	0,925 kg/m 2,0393 lb/m

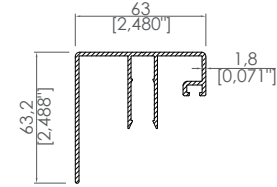

63x63,2 Kenar Cam Kapak Profili  
63x63,2 Side Glass Cover Profile

Ürün Kodu / Product Code	2008
Kalınlık / Thickness	1,8 mm
Ağırlık / Weight	1,060 kg/m 2,337 lb/m

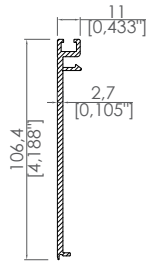

11x106,4 Dere ve Arka Kayıt Kapağı  
11x106,4 Gutter and Back Beam Cover Profile

Ürün Kodu / Product Code	2011
Kalınlık / Thickness	2,7 mm
Ağırlık / Weight	0,890 kg/m 1,962 lb/m

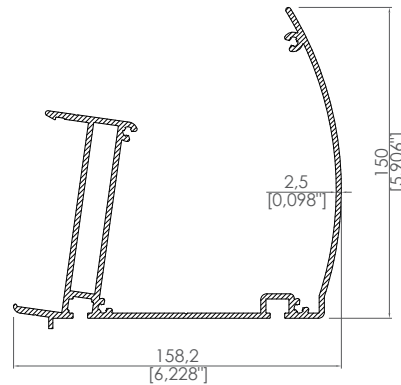

158,2x150 Oval Dere  
158,2x150 Oval Gutter

Ürün Kodu / Product Code	2012
Kalınlık / Thickness	2,5 mm
Ağırlık / Weight	4,115 kg/m 9,072 lb/m

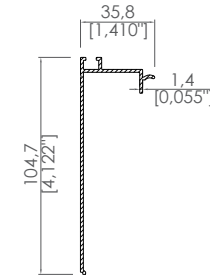

35,8x104,7 Dere ve Arka Kayıt Kapağı  
35,8x104,7 Gutter and Back Beam Cover Profile

Ürün Kodu / Product Code	2533
Kalınlık / Thickness	1,4 mm
Ağırlık / Weight	0,600 kg/m 1,3228 lb/m

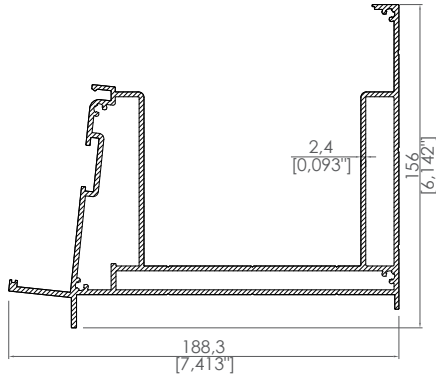

188,3x156 Düz Dere  
188,3x156 Gutter Profile

Ürün Kodu / Product Code	2530
Kalınlık / Thickness	2,4 mm
Ağırlık / Weight	5,399 kg/m 11,903 lb/m

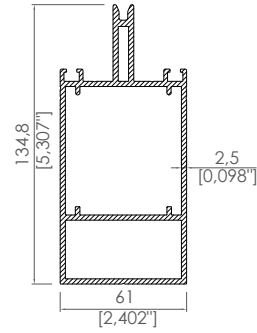

61x134,8 Cam Taşıyıcı  
61x134,8 Glass Carrier Profile

Ürün Kodu / Product Code	2005
Kalınlık / Thickness	2,5 mm
Ağırlık / Weight	3,230 kg/m 7,121 lb/m

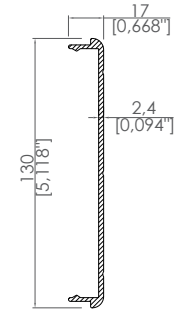

17x130 Dikme Kapak Profili  
17x130 Pillar Cover Profile

Ürün Kodu / Product Code	2010
Kalınlık / Thickness	2,4 mm
Ağırlık / Weight	1,025 kg/m 2,2597 lb/m

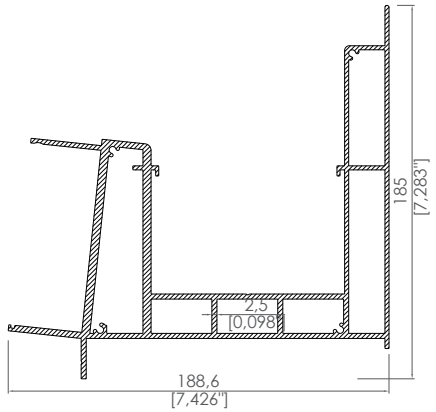

188x185 Düz Dere  
188x185 Gutter Profiler

Ürün Kodu / Product Code	3535
Kalınlık / Thickness	2,5 mm
Ağırlık / Weight	6,827 kg/m 15,05 lb/m

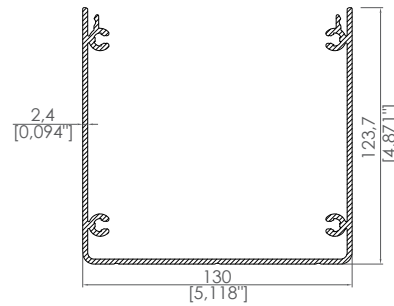

120x123 Dikme Gövde  
120x123 Pillar Main

Ürün Kodu / Product Code	2009
Kalınlık / Thickness	2,4 mm
Ağırlık / Weight	3,057 kg/m 6,74 lb/m

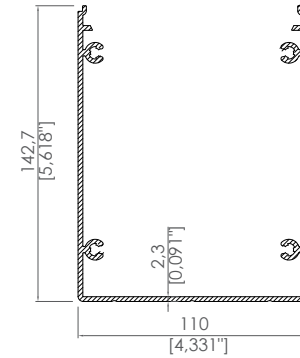

110x142,7 Dikme Gövde  
110x142,7 Pillar Main

Ürün Kodu / Product Code	2301
Kalınlık / Thickness	2,3 mm
Ağırlık / Weight	3,003 kg/m 6,62 lb/m

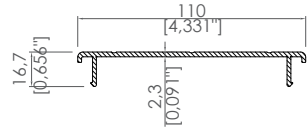

110x145 Dikme Kapak Profili  
110x145 Pillar Cover Profile

Ürün Kodu / Product Code	2302
Kalınlık / Thickness	2,3 mm
Ağırlık / Weight	0,846 kg/m 1,865 lb/m

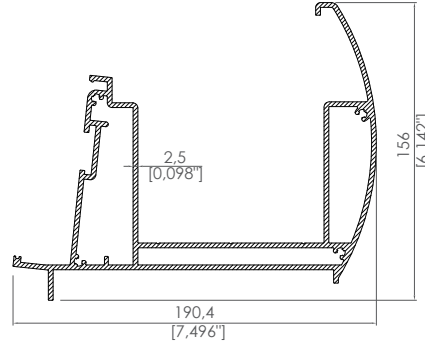

190,4X156 Oval Dere Profili  
190,4X156 Oval Gutter

Ürün Kodu / Product Code	2594
Kalınlık / Thickness	2,5 mm
Ağırlık / Weight	5,619 kg/m 12,388 lb/m

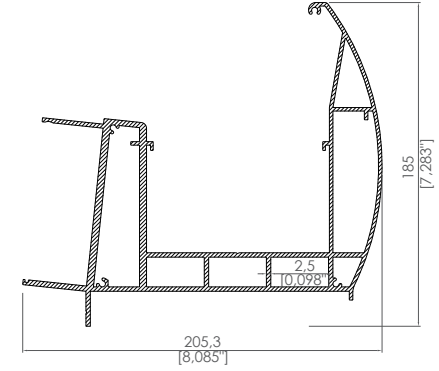

205,3X185 Oval Dere Profili  
205,3X185 Oval Gutter Profile

Ürün Kodu / Product Code	3536
Kalınlık / Thickness	2,5 mm
Ağırlık / Weight	7,095 kg/m 15,642 lb/m

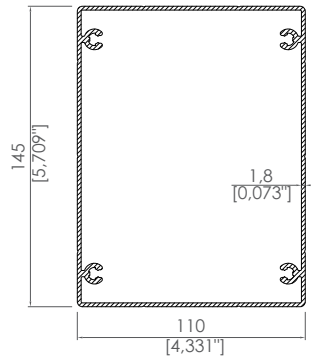

110x145 Dikme Profili  
110x145 Pillar Profile

Ürün Kodu / Product Code	2111
Kalınlık / Thickness	1,8 mm
Ağırlık / Weight	3,044 kg/m 6,711 lb/m

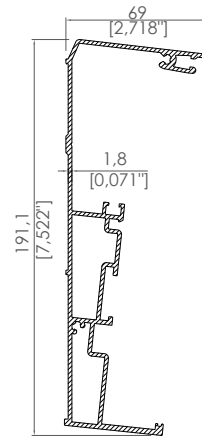

69x191 Arka Kayıt  
69x191 Back Beam

Ürün Kodu / Product Code	2532
Kalınlık / Thickness	1,8 mm
Ağırlık / Weight	2,651 kg/m 5,844 lb/m

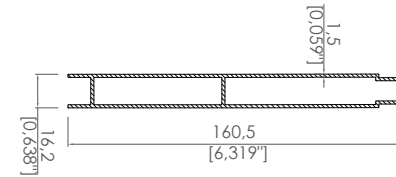

15x160 Panel Profili  
15x160 Panel Profile

Ürün Kodu / Product Code	2546
Kalınlık / Thickness	1,5 mm
Ağırlık / Weight	1,465 kg/m 3,23 lb/m

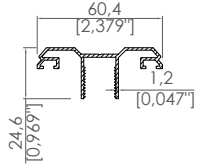

60,4x24,6 Cam Kapak Profili  
60,4x24,6 Glass Cover Profile

Ürün Kodu / Product Code	2534
Kalınlık / Thickness	1,2 mm
Ağırlık / Weight	0,515 kg/m 1,1354 lb/m

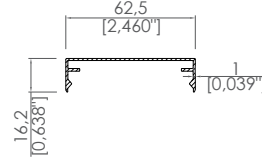

62,5x16,2 Orta Kapak Profili  
62,5x16,2 Middle Profile Cover

Ürün Kodu / Product Code	2535
Kalınlık / Thickness	1 mm
Ağırlık / Weight	0,312 kg/m 0,6878 lb/m

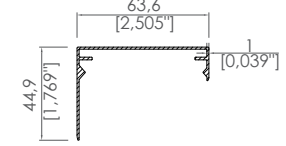

63,6x44,9 Kenar Kapak Profili  
63,6x44,9 Side Profile Cover

Ürün Kodu / Product Code	2536
Kalınlık / Thickness	1 mm
Ağırlık / Weight	0,415 kg/m 0,915 lb/m

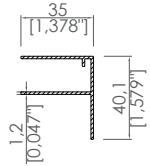

F Profil  
F Profile

Ürün Kodu / Product Code	2643
Kalınlık / Thickness	1,2 mm
Ağırlık / Weight	0,365 kg/m 0,8047 lb/m

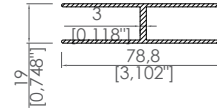

H Profil  
H Profile

Ürün Kodu / Product Code	2642
Kalınlık / Thickness	3 mm
Ağırlık / Weight	0,770 kg/m 1,6976 lb/m

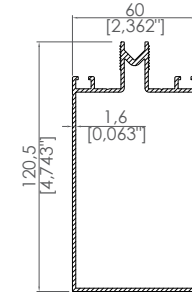

Standart Cam Taşıyıcı  
Standart Glass Carrier Profile

Ürün Kodu / Product Code	2490
Kalınlık / Thickness	1,6 mm
Ağırlık / Weight	1,721 kg/m 3,794 lb/m

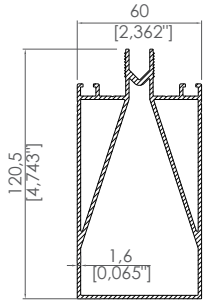

**Destekli Cam Taşıyıcı 1**  
Supported Glass Carrier Profile 1

Ürün Kodu / Product Code	2935
Kalınlık / Thickness	1,6 mm
Ağırlık / Weight	2,440 kg/m 5,379 lb/m

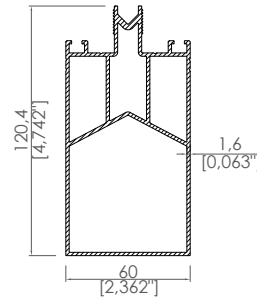

**Destekli Cam Taşıyıcı 2**  
Supported Glass Carrier Profile 2

Ürün Kodu / Product Code	2490
Kalınlık / Thickness	1,6 mm
Ağırlık / Weight	2,274 kg/m 5,013 lb/m

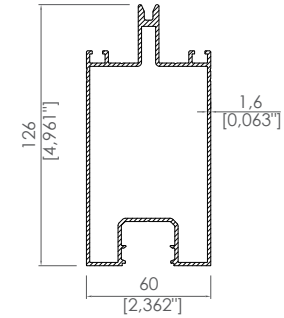

**Şerit Ledli Cam Taşıyıcı Profili**  
Glass Carrier Profile Linear Led

Ürün Kodu / Product Code	2717
Kalınlık / Thickness	1,6 mm
Ağırlık / Weight	1,968 kg/m 4,339 lb/m

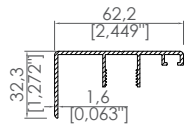

**62,2x32,3 Kenar Cam Kapak Profili**  
62,2x32,3 Side Glass Cover Profile

Ürün Kodu / Product Code	2491
Kalınlık / Thickness	1,6 mm
Ağırlık / Weight	0,559 kg/m 1,2324 lb/m

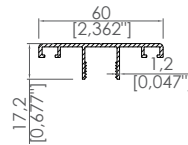

**60x17,2 Cam Kapak Profili**  
60x17,2 Glass Cover Profile

Ürün Kodu / Product Code	2492
Kalınlık / Thickness	1,2 mm
Ağırlık / Weight	0,464 kg/m 1,023 lb/m

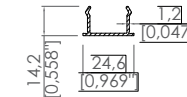

**Cam Taşıyıcı Kapağı**  
Glass Carrier Cover

Ürün Kodu / Product Code	2716
Kalınlık / Thickness	1,2 mm
Ağırlık / Weight	0,166 kg/m 0,366 lb/m

## HAREKETLİ VE SABİT CAM SİSTEMLERİ

MOVABLE AND FIXED GLASS  
CEILING SYSTEMS

**Pergamon Sürgülü Cam Çatı Sistemleri**  
Pergamon Sliding Glass Roof Systems



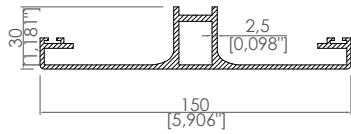

Alt Ray Profili  
Bottom Rail Profile

Ürün Kodu / Product Code	2924
Kalınlık / Thickness	2,5 mm
Ağırlık / Weight	1,776 kg/m 3,9154 lb/m

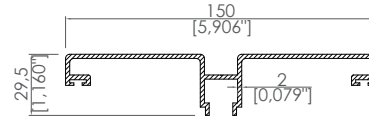

Üst Ray Profili  
Top Rail Profile

Ürün Kodu / Product Code	2923
Kalınlık / Thickness	2 mm
Ağırlık / Weight	1,453 kg/m 3,203 lb/m

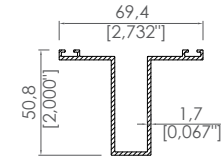

Panel Kavrama Profili  
Panel Holder Profile

Ürün Kodu / Product Code	2925
Kalınlık / Thickness	1,7 mm
Ağırlık / Weight	0,795 kg/m 1,7527 lb/m

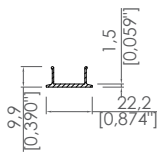

Ayarlanabilir Ray Profil Kapağı  
Rail Adjusting Profile Cover

Ürün Kodu / Product Code	2926
Kalınlık / Thickness	1,5 mm
Ağırlık / Weight	0,120 kg/m 0,26455 lb/m

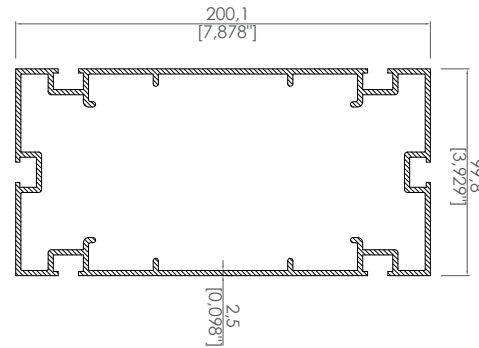

Arka Kayıt  
Back Beam

Ürün Kodu / Product Code	2930
Kalınlık / Thickness	2,5 mm
Ağırlık / Weight	4,945 kg/m 10,902 lb/m

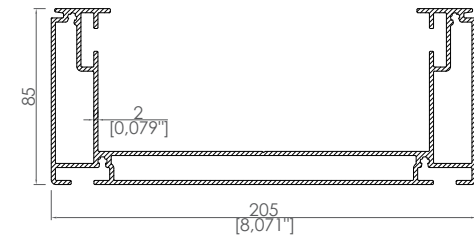

Dere Profili  
Gutter Profile

Ürün Kodu / Product Code	2337
Kalınlık / Thickness	2 mm
Ağırlık / Weight	4,560 kg/m 10,053 lb/m

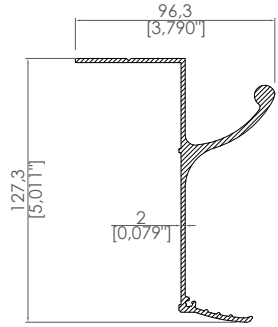

Arka Kayıt Bağlantı Ray Profili  
Rail - Back Beam Connection Profile

Ürün Kodu / Product Code	2929
Kalınlık / Thickness	2 mm
Ağırlık / Weight	1,925 kg/m 4,244 lb/m

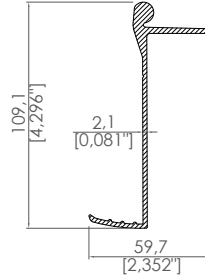

Dere Bağlantı Ray Profili  
Rail - Gutter Connection Profile

Ürün Kodu / Product Code	2928
Kalınlık / Thickness	2,1 mm
Ağırlık / Weight	1,456 kg/m 3,21 lb/m

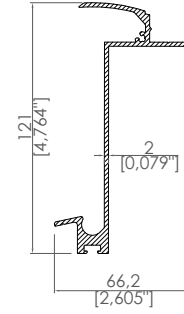

Ayarlanabilir Ray Profili  
Rail Adjusting Profile

Ürün Kodu / Product Code	2927
Kalınlık / Thickness	2 mm
Ağırlık / Weight	1,529 kg/m 3,371 lb/m

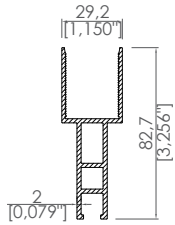

Cam Panel Kasa Profili  
Glass Panel Side Profile

Ürün Kodu / Product Code	2502
Kalınlık / Thickness	2 mm
Ağırlık / Weight	1,125 kg/m 2,48 lb/m

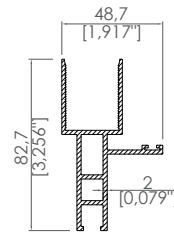

Panel Çekici Profili  
Panel Puller Profile

Ürün Kodu / Product Code	2503
Kalınlık / Thickness	2 mm
Ağırlık / Weight	1,300 kg/m 2,866 lb/m

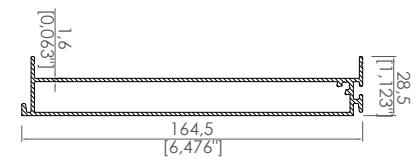

Dere Uzatma Profili  
Gutter Extension Profile

Ürün Kodu / Product Code	2338
Kalınlık / Thickness	1,6mm
Ağırlık / Weight	1,730 kg/m 3,814 lb/m

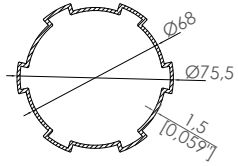

**Motor Borusu**  
Motor Tube

Ürün Kodu / Product Code	5312
Kalınlık / Thickness	1,5 mm
Ağırlık / Weight	1,100 kg/m 2,425 lb/m

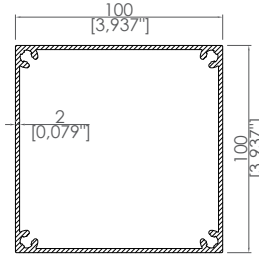

**100x100 Dikme Profil**  
100X100 Pillar Profile

Ürün Kodu / Product Code	6565
Kalınlık / Thickness	2 mm
Ağırlık / Weight	2,463 kg/m 5,43 lb/m

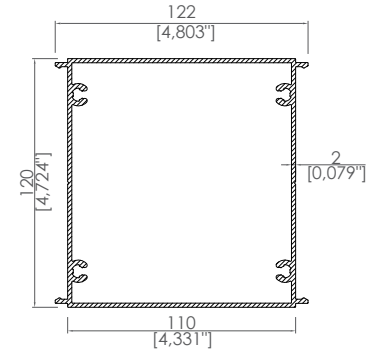

**122x120 Dikme Gövde Profili**  
122x120 Pillar Main Profile

Ürün Kodu / Product Code	2341
Kalınlık / Thickness	2 mm
Ağırlık / Weight	3,028 kg/m 6,676 lb/m

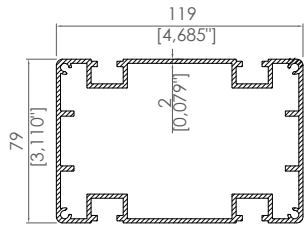

**Taşıyıcı Profil**  
Carrier Profile

Ürün Kodu / Product Code	5936
Kalınlık / Thickness	2 mm
Ağırlık / Weight	3,032 kg/m 6,684 lb/m

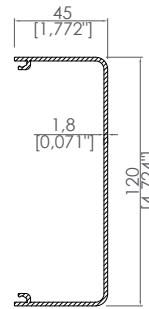

**Dikme Kapak Profili**  
Pillar Cover Profile

Ürün Kodu / Product Code	2342
Kalınlık / Thickness	1,8 mm
Ağırlık / Weight	1,055 kg/m 2,326 lb/m

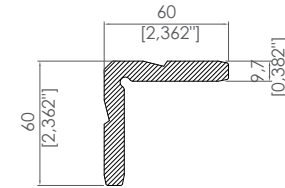

**Köşe Takoz Profili**  
Corner Block Profile

Ürün Kodu / Product Code	3096
Kalınlık / Thickness	9,7 mm
Ağırlık / Weight	2,734 kg/m 6,027 lb/m

**HAREKETLİ VE SABİT  
CAM SİSTEMLERİ**  
MOVABLE AND FIXED GLASS  
CEILING SYSTEMS

**Karya Küp Veranda Sistemleri**  
Carians Cube Veranda Systems



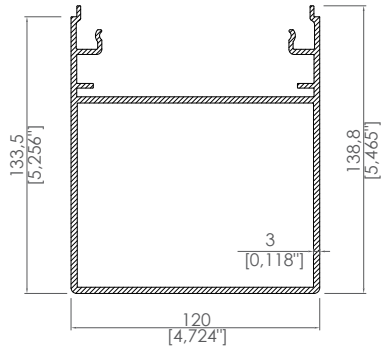

**Yan Kayıt Profili**  
Side Beam Profile

Ürün Kodu / Product Code	3609
Kalınlık / Thickness	3 mm
Ağırlık / Weight	4,382 kg/m 9,66 lb/m

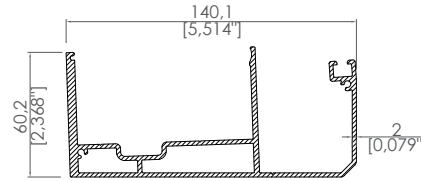

**Arka Kayıt Profili**  
Back Beam Profile

Ürün Kodu / Product Code	3617
Kalınlık / Thickness	2 mm
Ağırlık / Weight	2,745 kg/m 6,052 lb/m

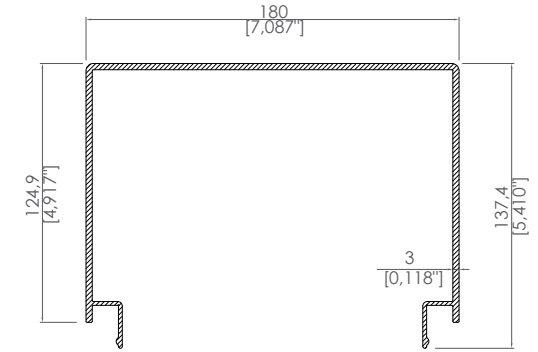

**Dikme Kapak Profili**  
Pillar Cover Profile

Ürün Kodu / Product Code	3612
Kalınlık / Thickness	3 mm
Ağırlık / Weight	3,791 kg/m 8,358 lb/m

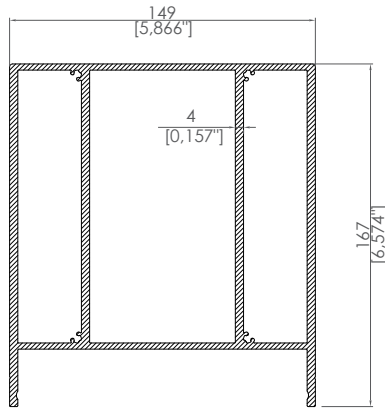

**Orta Destek Profili**  
Middle Support Profile

Ürün Kodu / Product Code	3052
Kalınlık / Thickness	4 mm
Ağırlık / Weight	8,881 kg/m 19,58 lb/m

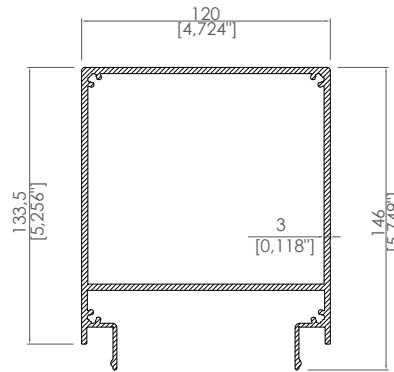

**Yan Kayıt Üst Profili**  
Side Beam Top Profile

Ürün Kodu / Product Code	3610
Kalınlık / Thickness	3 mm
Ağırlık / Weight	4,501 kg/m 9,923 lb/m

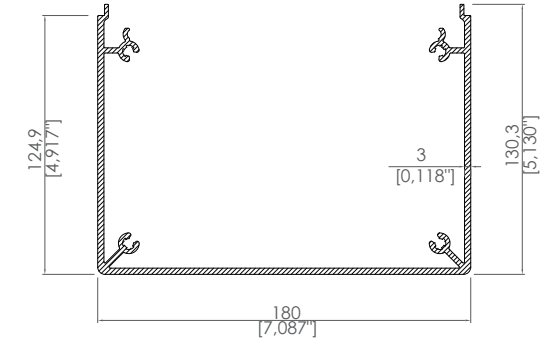

**Dikme Gövde Profili**  
Pillar Main Profile

Ürün Kodu / Product Code	3611
Kalınlık / Thickness	3 mm
Ağırlık / Weight	4,314 kg/m 9,51 lb/m

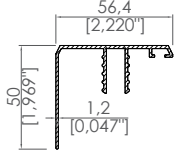

Kenar Cam Kapak Profili  
Glass Cover Side Profile

Ürün Kodu / Product Code	3615
Kalınlık / Thickness	1,2 mm
Ağırlık / Weight	0,594 kg/m 1,3095 lb/m

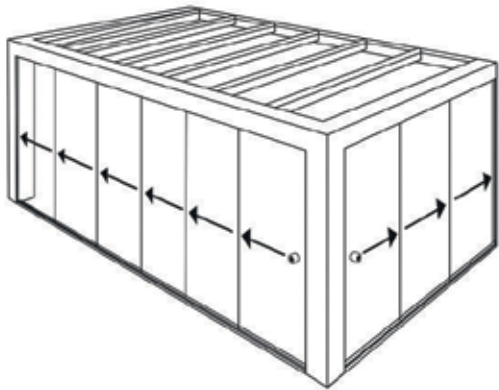

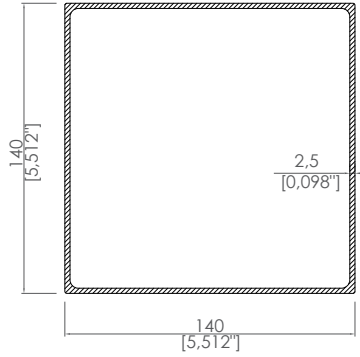

140x140 Dikme Profili  
140x140 Pillar Profile

Ürün Kodu / Product Code	3054
Kalınlık / Thickness	2,5 mm
Ağırlık / Weight	3,780 kg/m 8,333 lb/m

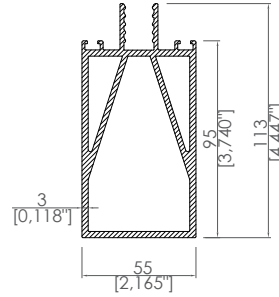

Cam Taşıyıcı Profil  
Glass Carrier Profile

Ürün Kodu / Product Code	3613
Kalınlık / Thickness	3 mm
Ağırlık / Weight	3,431 kg/m 7,564 lb/m

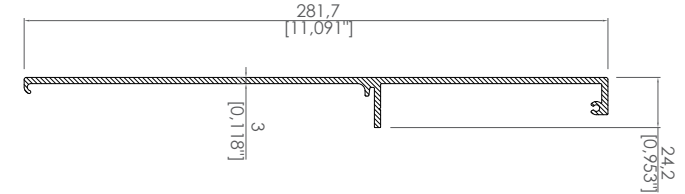

Dere Kapak Profili  
Gutter Cover Profile

Ürün Kodu / Product Code	3607
Kalınlık / Thickness	3 mm
Ağırlık / Weight	2,713 kg/m 5,981 lb/m

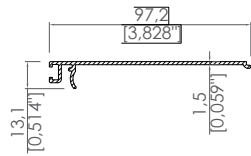

Dere ve Arka Kayıt Kapağı  
Gutter and Back Beam Cover Profile

Ürün Kodu / Product Code	3616
Kalınlık / Thickness	1,5 mm
Ağırlık / Weight	0,507 kg/m 1,117 lb/m

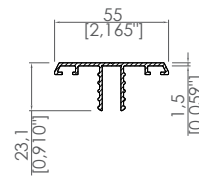

Orta Cam Kapak Profili  
Middle Glass Cover Profile

Ürün Kodu / Product Code	3614
Kalınlık / Thickness	1,5 mm
Ağırlık / Weight	0,469 kg/m 1,034 lb/m

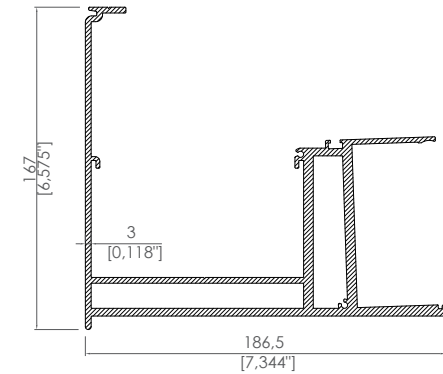

Dere Profili  
Gutter Profile

Ürün Kodu / Product Code	3608
Kalınlık / Thickness	3 mm
Ağırlık / Weight	7,425 kg/m 16,37 lb/m

**CAM SİSTEMLERİ**  
GLASS SYSTEMS

**Likya Modena Sürme Sistemleri**  
Luqqa Modena Sliding Systems



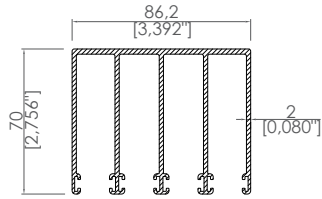

**Dörtlü Üst Ray Profili**  
Four Rail Top Profile

Ürün Kodu / Product Code	2958
Kalınlık / Thickness	2 mm
Ağırlık / Weight	2,585 kg/m 5,699 lb/m

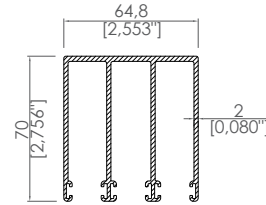

**Üçlü Üst Ray Profili**  
Three Rail Top Profile

Ürün Kodu / Product Code	2957
Kalınlık / Thickness	2 mm
Ağırlık / Weight	2,025 kg/m 4,464 lb/m

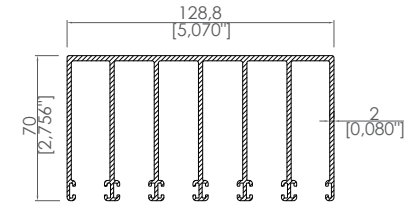

**Altılı Üst Ray Profili**  
Six Rail Top Profile

Ürün Kodu / Product Code	2690
Kalınlık / Thickness	1,8 mm
Ağırlık / Weight	1,060 kg/m 2,337 lb/m

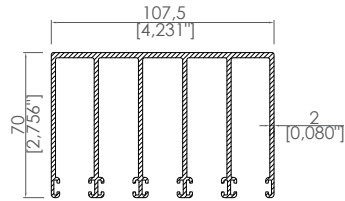

**Beşli Üst Ray Profili**  
Five Rail Top Profile

Ürün Kodu / Product Code	2959
Kalınlık / Thickness	2 mm
Ağırlık / Weight	3,144 kg/m 6,931 lb/m

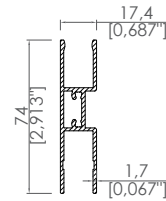

**Sürme Panel Alt Profili**  
Sliding Glass Bottom Profile

Ürün Kodu / Product Code	2868
Kalınlık / Thickness	1,7 mm
Ağırlık / Weight	0,825 kg/m 1,818 lb/m

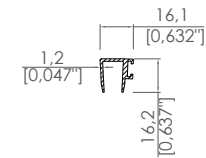

**Cam Tutucu Profili**  
Glass Side Profile

Ürün Kodu / Product Code	3405
Kalınlık / Thickness	1,2 mm
Ağırlık / Weight	0,179 kg/m 0,3946 lb/m

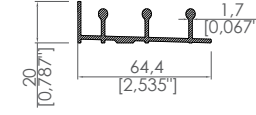

Üçlü Ray Alt Profili  
Three Rail Bottom Profile

Ürün Kodu / Product Code	2869
Kalınlık / Thickness	1,7 mm
Ağırlık / Weight	0,696 kg/m 1,5344 lb/m

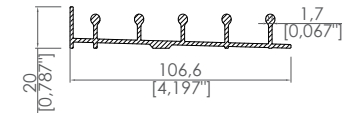

Beşli Ray Alt Profili  
Five Rail Bottom Profile

Ürün Kodu / Product Code	2871
Kalınlık / Thickness	1,7 mm
Ağırlık / Weight	1,089 kg/m 2,401 lb/m

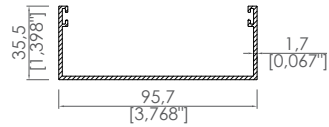

**Dörtlü Yan Dikme Profili**  
Four Rail Side Profile

Ürün Kodu / Product Code	2962
Kalınlık / Thickness	1,7 mm
Ağırlık / Weight	0,810 kg/m 1,7857 lb/m

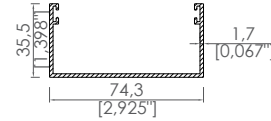

**Üçlü Yan Dikme Profili**  
Three Rail Side Profile

Ürün Kodu / Product Code	2961
Kalınlık / Thickness	1,7 mm
Ağırlık / Weight	0,710 kg/m 1,5653 lb/m

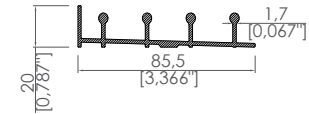

**Dörtlü Ray Alt Profili**  
Four Rail Bottom Profile

Ürün Kodu / Product Code	2870
Kalınlık / Thickness	1,7 mm
Ağırlık / Weight	0,894 kg/m 1,971 lb/m

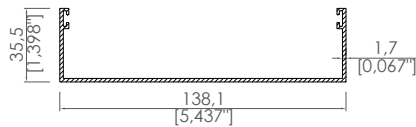

**Altılı Yan Dikme Profili**  
Six Rail Side Profile

Ürün Kodu / Product Code	2964
Kalınlık / Thickness	1,7 mm
Ağırlık / Weight	1,010 kg/m 2,2267 lb/m

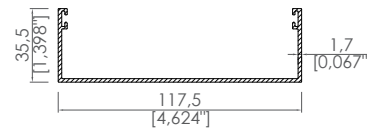

**Beşli Yan Dikme Profili**  
Five Rail Side Profile

Ürün Kodu / Product Code	2963
Kalınlık / Thickness	1,7 mm
Ağırlık / Weight	0,910 kg/m 2,0062 lb/m

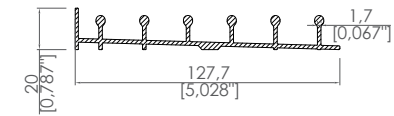

**Altılı Ray Alt Profili**  
Six Rail Bottom Profile

Ürün Kodu / Product Code	2872
Kalınlık / Thickness	1,7 mm
Ağırlık / Weight	1,287 kg/m 2,8373 lb/m

**CAM SİSTEMLERİ**  
GLASS SYSTEMS

**Tyana Giyotin Cam Sistemleri**  
Tyana Guillotine Glass Systems



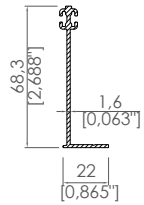

Ray Orta Profili  
Rail Middle Profile

Ürün Kodu / Product Code	37268
Kalınlık / Thickness	1,6 mm
Ağırlık / Weight	0,464 kg/m 1,023 lb/m

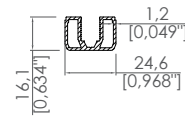

8 mm Cam Adaptörü  
8 mm Glass Adapter

Ürün Kodu / Product Code	37281
Kalınlık / Thickness	1,2 mm
Ağırlık / Weight	0,353 kg/m 0,7782 lb/m

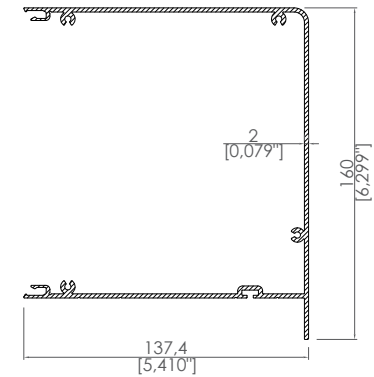

Motor Kutusu Profili  
Motor Box Profile

Ürün Kodu / Product Code	37272
Kalınlık / Thickness	2 mm
Ağırlık / Weight	2,700 kg/m 5,952 lb/m

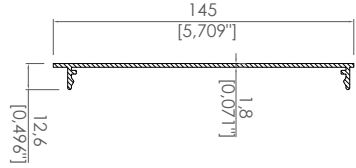

**Motor Kutusu Kapak Profili**  
Motor Box Cover Profile

Ürün Kodu / Product Code	37271
Kalınlık / Thickness	1,8 mm
Ağırlık / Weight	0,847 kg/m 1,8673 lb/m

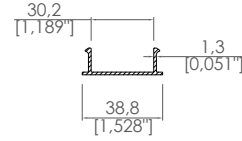

**Ray Kapak Profili**  
Rail Cover Profile

Ürün Kodu / Product Code	37270
Kalınlık / Thickness	1,3 mm
Ağırlık / Weight	0,230 kg/m 0,5071 lb/m

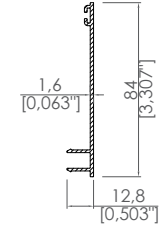

**Yan Ray Kapak Profili**  
Side Rail Cover Profile

Ürün Kodu / Product Code	37269
Kalınlık / Thickness	1,6 mm
Ağırlık / Weight	0,475 kg/m 1,0472 lb/m

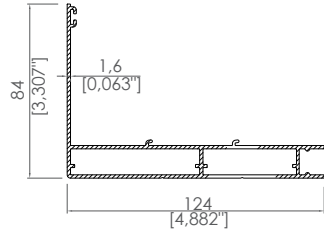

**Yan Ray Profili**  
Side Rail Profile

Ürün Kodu / Product Code	37267
Kalınlık / Thickness	1,6 mm
Ağırlık / Weight	0,559 kg/m 1,2324 lb/m

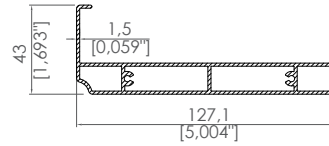

**Alt Baza Profili**  
Sill Profile

Ürün Kodu / Product Code	37266
Kalınlık / Thickness	1,2 mm
Ağırlık / Weight	0,464 kg/m 1,023 lb/m

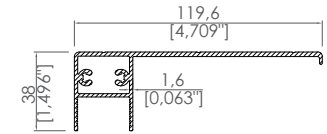

**24mm Cam Trabzan Profili**  
24mm Glass Handrail Profile

Ürün Kodu / Product Code	37265
Kalınlık / Thickness	1,6 mm
Ağırlık / Weight	1,285 kg/m 2,833 lb/m

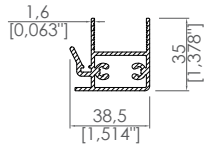

24mm Cam Çekici Profili  
24mm Glass Puller Profile

Ürün Kodu / Product Code	37264
Kalınlık / Thickness	1,6 mm
Ağırlık / Weight	0,825 kg/m 1,8188 lb/m

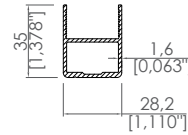

24mm Cam Çerçeve Profili  
24mm Glass Frame Profile

Ürün Kodu / Product Code	37263
Kalınlık / Thickness	1,6 mm
Ağırlık / Weight	0,545 kg/m 1,2015 lb/m

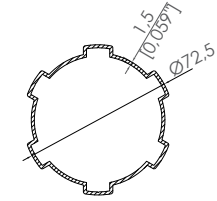

Motor Tüp Borusu  
Motor Tube Profile

Ürün Kodu / Product Code	37115
Kalınlık / Thickness	1,5 mm
Ağırlık / Weight	0,992 kg/m 2,187 lb/m

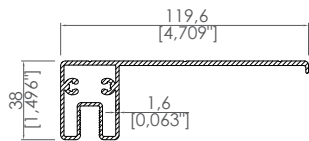

8mm Cam Trabzan Profili  
8mm Glass Handrail Profile

Ürün Kodu / Product Code	37275
Kalınlık / Thickness	1,6 mm
Ağırlık / Weight	1,406 kg/m 3,1 lb/m

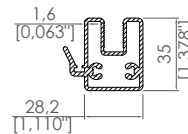

8mm Cam Panel Çekici Profili  
8mm Glass Panel Puller Profile

Ürün Kodu / Product Code	37274
Kalınlık / Thickness	1,6 mm
Ağırlık / Weight	0,909 kg/m 2,004 lb/m

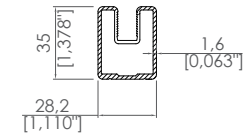

8 mm Cam Çerçeve Profili  
8 mm Glass Frame Profile

Ürün Kodu / Product Code	37273
Kalınlık / Thickness	1,6 mm
Ağırlık / Weight	0,664 kg/m 1,464 lb/m

**CAM SİSTEMLERİ**  
GLASS SYSTEMS

**Tabal Isı Camlı Sürme Sistemleri**  
Tabal Double Glass Sliding Systems



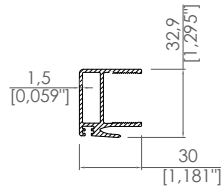

62,2x32,3 Kenar Cam Kapak Profili  
62,2x32,3 Side Glass Cover Profile

Ürün Kodu / Product Code	2065
Kalınlık / Thickness	1,5 mm
Ağırlık / Weight	0,585 kg/m 1,2897 lb/m

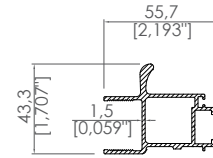

60x17,2 Cam Kapak Profili  
60x17,2 Glass Cover Profile

Ürün Kodu / Product Code	2068
Kalınlık / Thickness	1,5 mm
Ağırlık / Weight	0,878 kg/m 1,9357 lb/m

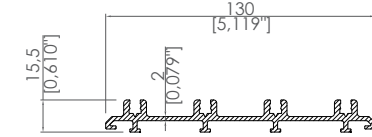

Cam Taşıyıcı Kapağı  
Glass Carrier Cover

Ürün Kodu / Product Code	2070
Kalınlık / Thickness	2 mm
Ağırlık / Weight	1,480 kg/m 3,263 lb/m

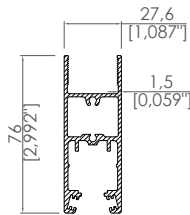

22mm Cam Panel Alt Profili  
22mm Glass Panel Bottom Profile

Ürün Kodu / Product Code	2565
Kalınlık / Thickness	1,5 mm
Ağırlık / Weight	1,205 kg/m 2,6566 lb/m

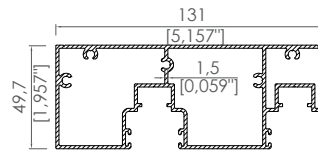

Yan Ray Profili  
Side Rail Profile

Ürün Kodu / Product Code	2066
Kalınlık / Thickness	1,5 mm
Ağırlık / Weight	2,414 kg/m 5,322 lb/m

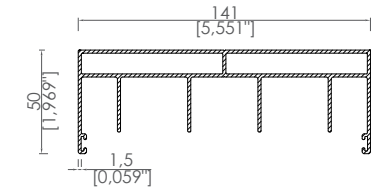

Üst Ray Profili  
Top Rail Profile

Ürün Kodu / Product Code	2069
Kalınlık / Thickness	1,5 mm
Ağırlık / Weight	2,054 kg/m 4,528 lb/m

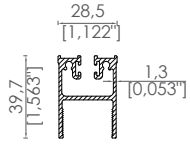

22 mm Cam Panel Üst Profili  
22 mm Glass Panel Top Profile

Ürün Kodu / Product Code	2071
Kalınlık / Thickness	1,3 mm
Ağırlık / Weight	0,703 kg/m 1,55 lb/m

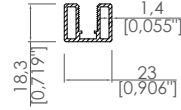

8 mm Cam Adaptör Profili  
8 mm Glass Adapter Profile

Ürün Kodu / Product Code	2150
Kalınlık / Thickness	1,4 mm
Ağırlık / Weight	0,375 kg/m 0,8267 lb/m

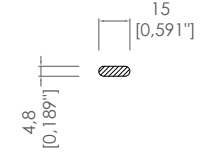

Alt Ray Teker Profili  
Bottom Rail Wheel Profile

Ürün Kodu / Product Code	2117
Kalınlık / Thickness	4,8 mm
Ağırlık / Weight	0,185 kg/m 0,40786 lb/m

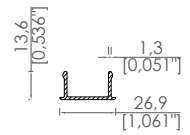

Yan Ray Profil Kapağı  
Side Rail Cover Profile

Ürün Kodu / Product Code	2067
Kalınlık / Thickness	1,3 mm
Ağırlık / Weight	0,186 kg/m 0,4101 lb/m

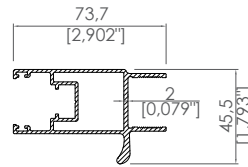

Orta Kanat Birleştirme Profili  
Middle Panel Side Profile

Ürün Kodu / Product Code	2149
Kalınlık / Thickness	2 mm
Ağırlık / Weight	1,160 kg/m 2,5574 lb/m

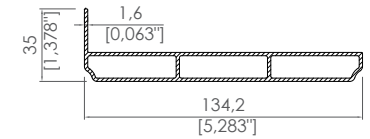

Baza Profili  
Sill Profile

Ürün Kodu / Product Code	2566
Kalınlık / Thickness	1,6 mm
Ağırlık / Weight	1,423 kg/m 3,137 lb/m



**CAM SİSTEMLERİ**  
GLASS SYSTEMS

**Karaman Katlanır Cam Sistemleri**  
Karamanids Folding Glass Systems



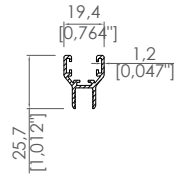

H - Profili  
H - Profile

Ürün Kodu / Product Code	2164
Kalınlık / Thickness	1,2 mm
Ağırlık / Weight	0,297 kg/m 0,6548 lb/m

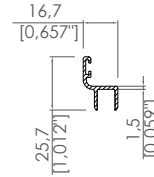

L - Profili  
L - Profile

Ürün Kodu / Product Code	2165
Kalınlık / Thickness	1,5 mm
Ağırlık / Weight	0,210 kg/m 0,463 lb/m

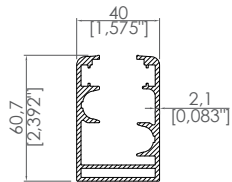

40x60,7 Ray Profili  
40x60,7 Rail Profile

Ürün Kodu / Product Code	37074
Kalınlık / Thickness	2,1 mm
Ağırlık / Weight	1,469 kg/m 3,2386 lb/m

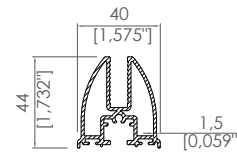

40x44 Panel Profili  
40x44 Panel Profile

Ürün Kodu / Product Code	37073
Kalınlık / Thickness	1,5 mm
Ağırlık / Weight	0,992 kg/m 2,187 lb/m



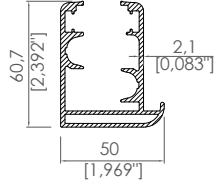

50x60,7 Ray Profili  
50x60,7 Rail Profile

Ürün Kodu / Product Code	2162
Kalınlık / Thickness	2,1 mm
Ağırlık / Weight	1,555 kg/m 3,428 lb/m

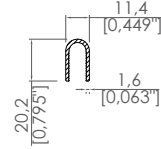

Kanat Dönüş Profili  
Panel turning profile

Ürün Kodu / Product Code	2163
Kalınlık / Thickness	1,6 mm
Ağırlık / Weight	0,182 kg/m 0,40124 lb/m

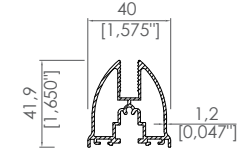

40x41,90 Panel Alt Ve Üst Profili  
40x41,90 Panel Top and Bottom Profile

Ürün Kodu / Product Code	32025
Kalınlık / Thickness	1,2 mm
Ağırlık / Weight	0,775 kg/m 1,7086 lb/m

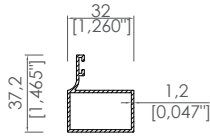

Geniş Yan Kasa Dikme Profili  
Thick Side Pillar Box Profile

Ürün Kodu / Product Code	37075
Kalınlık / Thickness	1,2 mm
Ağırlık / Weight	0,412 kg/m 0,9083 lb/m

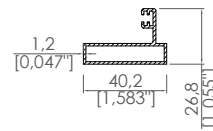

Dar Yan Kasa Dikme Profili  
Thin Side Pillar Box Profile

Ürün Kodu / Product Code	32024
Kalınlık / Thickness	1,2 mm
Ağırlık / Weight	0,430 kg/m 0,948 lb/m

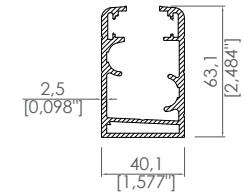

40x63 Ray Profili  
40x63 Rail Profile

Ürün Kodu / Product Code	32023
Kalınlık / Thickness	2,5 mm
Ağırlık / Weight	1,632 kg/m 3,598 lb/m

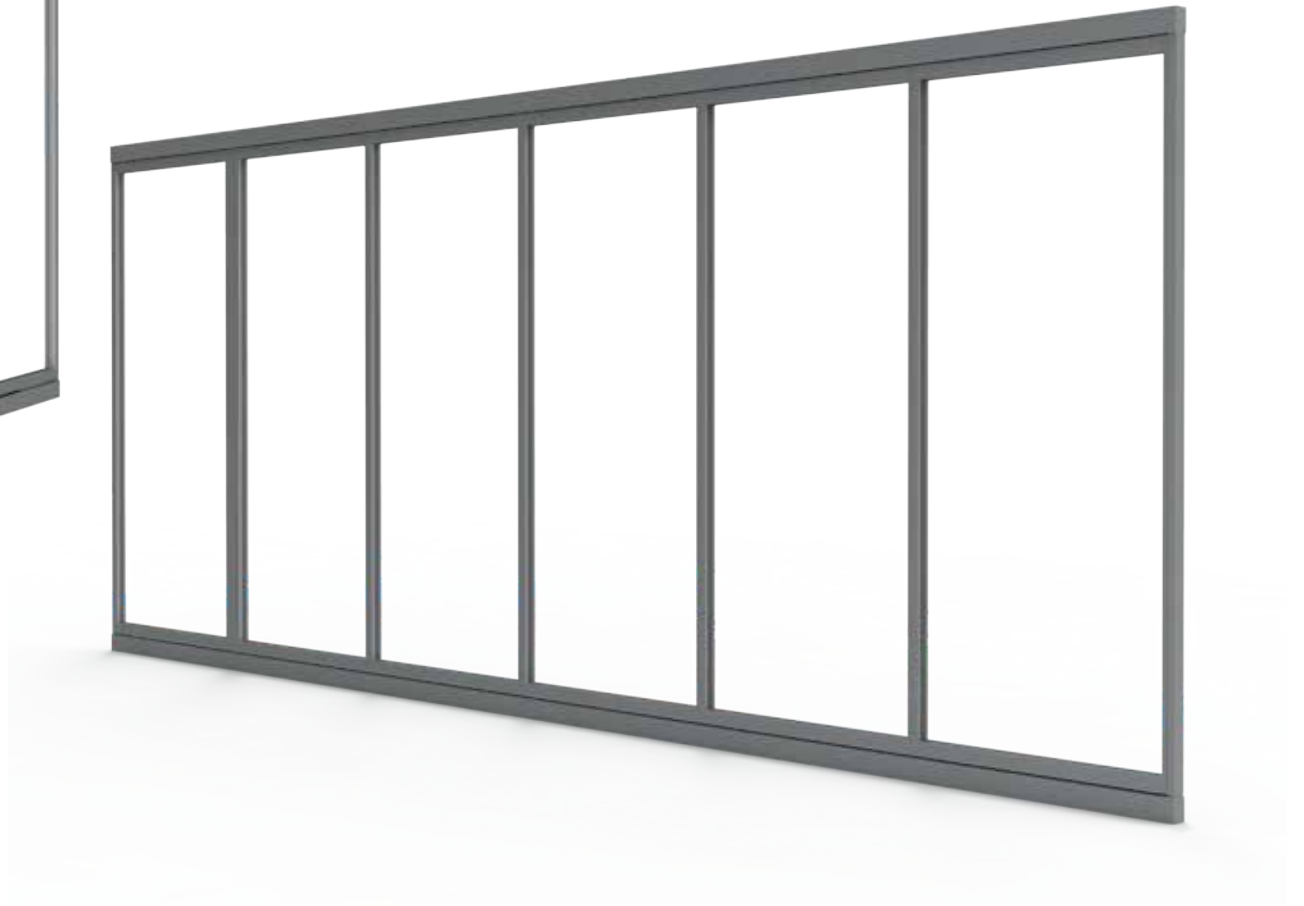

**CAM SİSTEMLERİ**  
GLASS SYSTEMS

**Selçuklu Çift Camlı Sürme Sistemleri**  
Seljuk Double Glass Sliding Systems



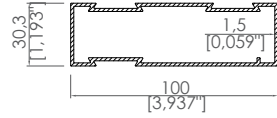

**Kasa Profili**  
Frame Profile

Ürün Kodu / Product Code	2407
Kalınlık / Thickness	1,5 mm
Ağırlık / Weight	1,1152 kg/m 2,5397 lb/m

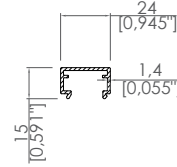

**Üst Ray Profili**  
Top Rail Profile

Ürün Kodu / Product Code	2410
Kalınlık / Thickness	1,4 mm
Ağırlık / Weight	0,235 kg/m 0,5181 lb/m

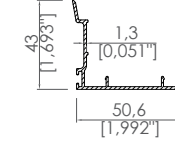

**Çerçeve Kenet Profili**  
Frame Bead Profile

Ürün Kodu / Product Code	2409
Kalınlık / Thickness	1,3 mm
Ağırlık / Weight	0,391 kg/m 0,862 lb/m

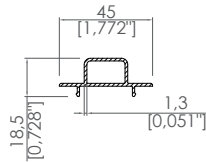

**Kapak Profili**  
Cover Profile

Ürün Kodu / Product Code	2414
Kalınlık / Thickness	1,3 mm
Ağırlık / Weight	0,347 kg/m 0,765 lb/m

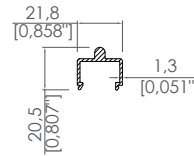

**Alt Ray Teker Profili**  
Bottom Rail Wheel Profile

Ürün Kodu / Product Code	2411
Kalınlık / Thickness	1,3 mm
Ağırlık / Weight	0,280 kg/m 0,6173 lb/m

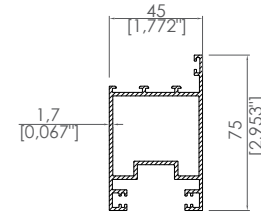

**Cam Kanat Profili**  
Glass Panel Profile

Ürün Kodu / Product Code	2408
Kalınlık / Thickness	1,7 mm
Ağırlık / Weight	1,261 kg/m 2,78 lb/m

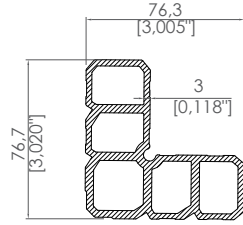

**Cam Panel Köşe Takoza**  
Glass Panel Corner Block Profile

Ürün Kodu / Product Code	2972
Kalınlık / Thickness	3 mm
Ağırlık / Weight	3,902 kg/m 8,602 lb/m

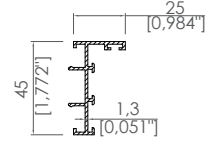

**Sabit Panel Yan Çerçeve Profili**  
Fix Panel Side Frame Profile

Ürün Kodu / Product Code	2415
Kalınlık / Thickness	1,3 mm
Ağırlık / Weight	0,142 kg/m 0,31306 lb/m

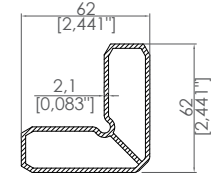

**Çerçeve Köşe Takoza Bağlantı Profili**  
Frame Corner Block Connection Profile

Ürün Kodu / Product Code	2971
Kalınlık / Thickness	2,1 mm
Ağırlık / Weight	3,650 kg/m 8,047 lb/m

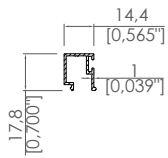

**Dar Cam Çıtası**  
Thin Glazing Bead Profile

Ürün Kodu / Product Code	2412
Kalınlık / Thickness	1 mm
Ağırlık / Weight	0,166 kg/m 0,366 lb/m

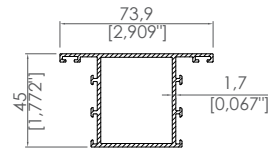

**Orta Kayıt Profili**  
Glass Middle Profile

Ürün Kodu / Product Code	2973
Kalınlık / Thickness	1,7 mm
Ağırlık / Weight	1,038 kg/m 2,2884 lb/m

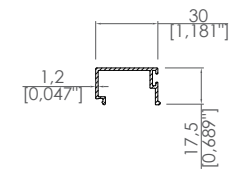

**Geniş Cam Çıtası**  
Thick Glazing Bead Profile

Ürün Kodu / Product Code	2413
Kalınlık / Thickness	1,2 mm
Ağırlık / Weight	0,239 kg/m 0,5269 lb/m



**CAM SİSTEMLERİ**  
GLASS SYSTEMS

**Urartu Çift Camlı Sürme Sistemleri**  
Urartu Double Glass Sliding Systems



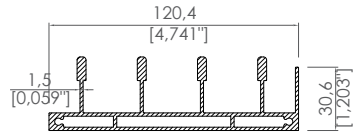

**Dörtlü Üst Ray Profili**  
Four Rail Top Profile

Ürün Kodu / Product Code	2470
Kalınlık / Thickness	1,5 mm
Ağırlık / Weight	2,092 kg/m 4,612 lb/m

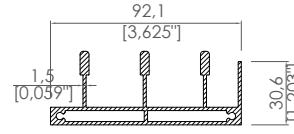

**Üçlü Üst Ray Profili**  
Three Rail Top Profile

Ürün Kodu / Product Code	2469
Kalınlık / Thickness	1,5 mm
Ağırlık / Weight	1,631 kg/m 3,596 lb/m

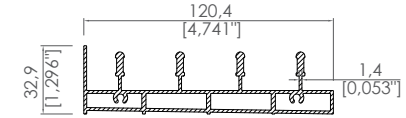

**Dörtlü Alt Ray Profili**  
Four Rail Bottom Profile

Ürün Kodu / Product Code	2377
Kalınlık / Thickness	1,4 mm
Ağırlık / Weight	1,818 kg/m 4,008 lb/m

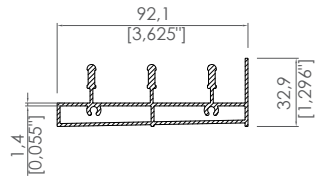

**Üçlü Alt Ray Profili**  
Three Rail Bottom Profile

Ürün Kodu / Product Code	2355
Kalınlık / Thickness	1,4 mm
Ağırlık / Weight	1,369 kg/m 3,018 lb/m

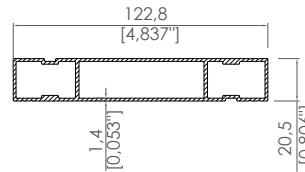

**Dörtlü Yan Ray Profili**  
Four Rail Side Profile

Ürün Kodu / Product Code	2376
Kalınlık / Thickness	1,4 mm
Ağırlık / Weight	1,266 kg/m 2,791 lb/m

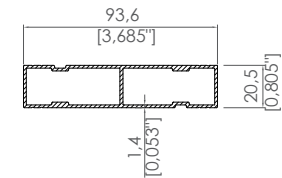

**Üçlü Yan Ray Profili**  
Three Rail Side Profile

Ürün Kodu / Product Code	2357
Kalınlık / Thickness	1,4 mm
Ağırlık / Weight	0,962 kg/m 2,099 lb/m

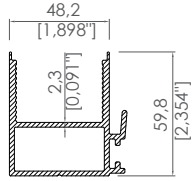

**Cam Panel Yan Profili**  
Glass Panel Side Profile

Ürün Kodu / Product Code	2467
Kalınlık / Thickness	2,3 mm
Ağırlık / Weight	0,404 kg/m 0,8907 lb/m

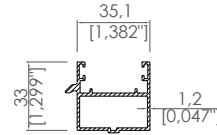

**Son Panel Profili**  
Side Panel Profile

Ürün Kodu / Product Code	3268
Kalınlık / Thickness	1,2 mm
Ağırlık / Weight	0,554 kg/m 1,2214 lb/m

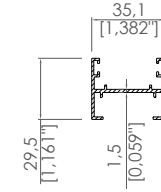

**Orta Panel Birleştirme Profili**  
Middle Panel Connection Profile

Ürün Kodu / Product Code	3270
Kalınlık / Thickness	1,5 mm
Ağırlık / Weight	0,420 kg/m 0,926 lb/m

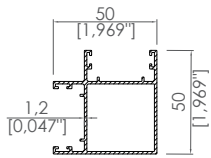

**Köşe Panel Profili**  
Corner Panel Profile

Ürün Kodu / Product Code	3271
Kalınlık / Thickness	1,2 mm
Ağırlık / Weight	0,748 kg/m 1,649 lb/m

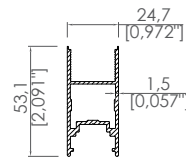

**İspanyolet Profili**  
Glass Panel Handle Lock Profile

Ürün Kodu / Product Code	3568
Kalınlık / Thickness	1,5 mm
Ağırlık / Weight	0,675 kg/m 1,488 lb/m

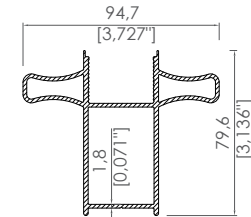

**Kulplu Panel Profili**  
Glass Panel Handle Profile

Ürün Kodu / Product Code	3215
Kalınlık / Thickness	1,8 mm
Ağırlık / Weight	0,848 kg/m 1,8695 lb/m

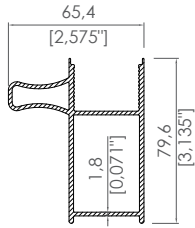

**Tek Kulplu Panel Profil**  
Glass Panel Single Handle Profile

Ürün Kodu / Product Code	3216
Kalınlık / Thickness	1,8 mm
Ağırlık / Weight	0,702 kg/m 1,5476 lb/m

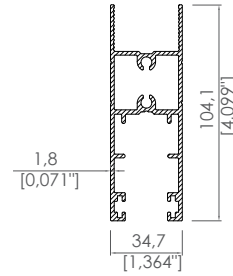

**Cam Panel Alt ve Üst Profili**  
Glass Panel Top and Bottom Profile

Ürün Kodu / Product Code	2356
Kalınlık / Thickness	1,8 mm
Ağırlık / Weight	0,764 kg/m 1,6843 lb/m

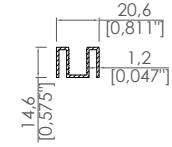

**8 mm Cam Adaptörü**  
8 mm Glass Adapter

Ürün Kodu / Product Code	3269
Kalınlık / Thickness	1,2 mm
Ağırlık / Weight	0,233 kg/m 0,5137 lb/m



**CAM SİSTEMLERİ**  
GLASS SYSTEMS

**Hazar Giyotin Cam Sistemleri**  
Hazar Guillotine Glass Systems



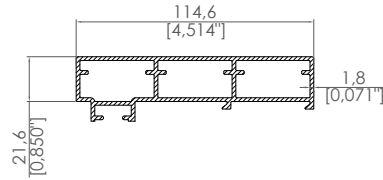

Yan Ray Profili  
Side Rail Profile

Ürün Kodu / Product Code	3570
Kalınlık / Thickness	1,8 mm
Ağırlık / Weight	1,772 kg/m 3,9066 lb/m

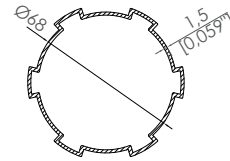

Motor Tüp Profili  
Motor Tube Profile

Ürün Kodu / Product Code	5312
Kalınlık / Thickness	1,5 mm
Ağırlık / Weight	1,100 kg/m 2,425 lb/m

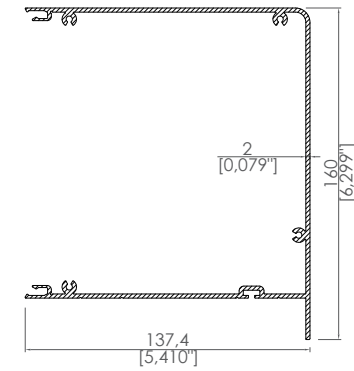

Motor Kutusu Profili  
Motor Box Profile

Ürün Kodu / Product Code	37272
Kalınlık / Thickness	2 mm
Ağırlık / Weight	2,700 kg/m 5,952 lb/m

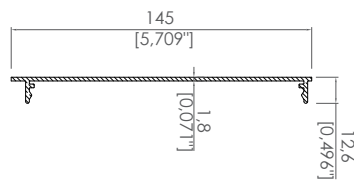

Motor Kutusu Kapak Profili  
Motor Box Cover Profile

Ürün Kodu / Product Code	37271
Kalınlık / Thickness	1,8 mm
Ağırlık / Weight	0,847 kg/m 1,8673 lb/m

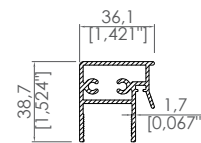

22mm Cam Panel Çekiçi Profili  
22mm Glass Panel Puller Profile

Ürün Kodu / Product Code	3068
Kalınlık / Thickness	1,7 mm
Ağırlık / Weight	0,860 kg/m 1,896 lb/m

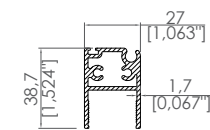

22mm Trabzan Profili  
22mm Handrail Profile

Ürün Kodu / Product Code	3067
Kalınlık / Thickness	1,7 mm
Ağırlık / Weight	0,800 kg/m 1,7637 lb/m

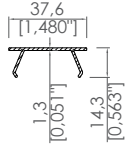

Ray Kapak Profili  
Rail Cover Profile

Ürün Kodu / Product Code	3688
Kalınlık / Thickness	1,3 mm
Ağırlık / Weight	0,214 kg/m 0,4718 lb/m

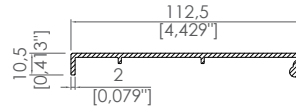

Trabzan Kapak Profili  
Handrail Cover Profile

Ürün Kodu / Product Code	3070
Kalınlık / Thickness	2 mm
Ağırlık / Weight	0,770 kg/m 1,6976 lb/m

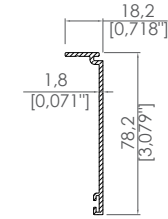

Yan Ray Kapak Profili  
Side Rail Cover Profile

Ürün Kodu / Product Code	3071
Kalınlık / Thickness	1,8 mm
Ağırlık / Weight	0,510 kg/m 1,1244 lb/m

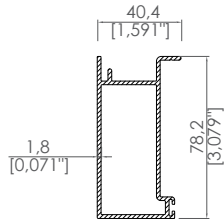

Yan Ray Dikme Profili  
Side Rail Pillar Profile

Ürün Kodu / Product Code	3072
Kalınlık / Thickness	1,8 mm
Ağırlık / Weight	1,170 kg/m 2,5794 lb/m

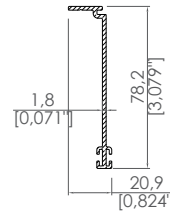

Yan Ray Orta Profil  
Side Rail Middle Profile

Ürün Kodu / Product Code	3073
Kalınlık / Thickness	1,8 mm
Ağırlık / Weight	0,540 kg/m 1,1905 lb/m

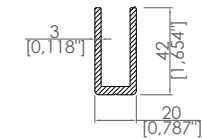

Zincir Askı Profili  
Chain Hanger Profile

Ürün Kodu / Product Code	3244
Kalınlık / Thickness	3 mm
Ağırlık / Weight	0,826 kg/m 1,821 lb/m

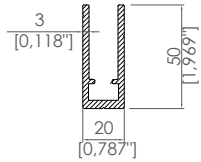

**Cam Panel Zincir Profili**  
Glass Panel Chain Profile

Ürün Kodu / Product Code	3245
Kalınlık / Thickness	3 mm
Ağırlık / Weight	0,981 kg/m 2,1627 lb/m

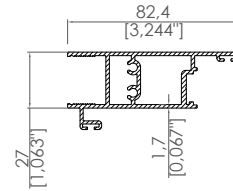

**Sabit Cam Yan Kilit Profili**  
Fixed Glass Side Lock Profile

Ürün Kodu / Product Code	3569
Kalınlık / Thickness	1,7 mm
Ağırlık / Weight	1,257 kg/m 2,771 lb/m

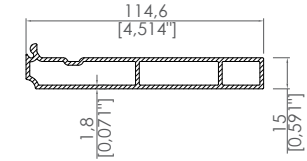

**Baza Profili**  
Sill Profile

Ürün Kodu / Product Code	3066
Kalınlık / Thickness	1,8 mm
Ağırlık / Weight	1,400 kg/m 3,0865 lb/m

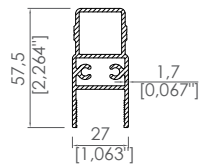

**22mm Cam Panel Yan Profili**  
22mm Glass Panel Side Profile

Ürün Kodu / Product Code	3064
Kalınlık / Thickness	1,7 mm
Ağırlık / Weight	1,030 kg/m 2,2708 lb/m

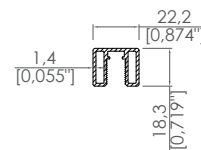

**8mm Cam Adaptor**  
8mm Glass Adapter

Ürün Kodu / Product Code	3065
Kalınlık / Thickness	1,4 mm
Ağırlık / Weight	0,370 kg/m 0,8157 lb/m



**ZİP PERDE SİSTEMLERİ**  
ZIP CURTAIN SYSTEMS

**Dikey Perde Sistemleri**  
Vertical Curtain Systems



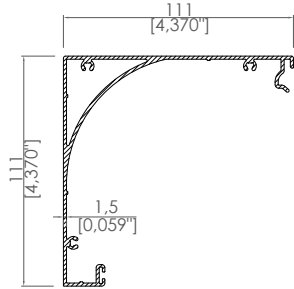

**Motor Kutusu Profili**  
Motor Box Profile

Ürün Kodu / Product Code	2878
Kalınlık / Thickness	1,5 mm
Ağırlık / Weight	1,585 kg/m 3,494 lb/m

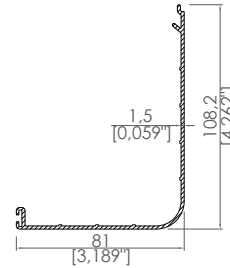

**Motor Kutusu Kapagı Profili**  
Motor Box Cover Profile

Ürün Kodu / Product Code	2875
Kalınlık / Thickness	1,5 mm
Ağırlık / Weight	0,837 kg/m 1,8453 lb/m

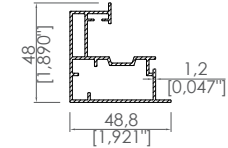

**Ray Profili**  
Rail Profile

Ürün Kodu / Product Code	2877
Kalınlık / Thickness	1,2 mm
Ağırlık / Weight	0,726 kg/m 1,6006 lb/m

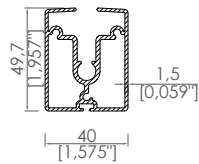

**Kumaş Alt Profili**  
Fabric Bottom Profile

Ürün Kodu / Product Code	2937
Kalınlık / Thickness	1,5 mm
Ağırlık / Weight	1,201 kg/m 2,648 lb/m

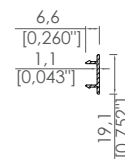

**Ray Vida Kapağı**  
Rail Screw Cover

Ürün Kodu / Product Code	2876
Kalınlık / Thickness	1,1 mm
Ağırlık / Weight	0,084 kg/m 0,1852 lb/m

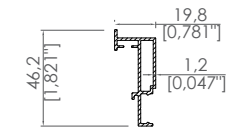

**Ray Kapağı Profili**  
Rail Cover Profile

Ürün Kodu / Product Code	2874
Kalınlık / Thickness	1,2 mm
Ağırlık / Weight	0,382 kg/m 0,8422 lb/m

**ZİP PERDE SİSTEMLERİ**  
ZIP CURTAIN SYSTEMS

**Yatay Perde Sistemleri**  
Horizontal Curtain Systems



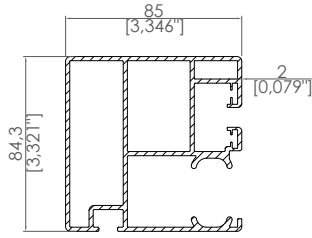

Ray Profili  
Rail Profile

Ürün Kodu / Product Code	3178
Kalınlık / Thickness	2 mm
Ağırlık / Weight	2,981 kg/m 6,572 lb/m

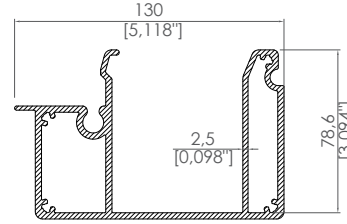

Kumaş Ön Profil  
Fabric Front Profile

Ürün Kodu / Product Code	3180
Kalınlık / Thickness	2,5 mm
Ağırlık / Weight	3,905 kg/m 8,609 lb/m

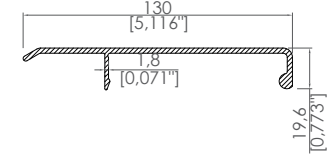

Kumaş Profil Kapak  
Fabric Front Profile Cover

Ürün Kodu / Product Code	3179
Kalınlık / Thickness	1,8 mm
Ağırlık / Weight	1,135 kg/m 2,502 lb/m

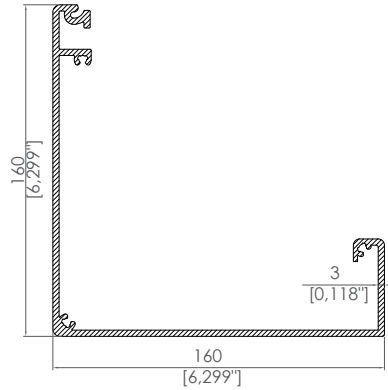

Motor Kutusu  
Motor Box

Ürün Kodu / Product Code	3181
Kalınlık / Thickness	3 mm
Ağırlık / Weight	3,580 kg/m 7,893 lb/m

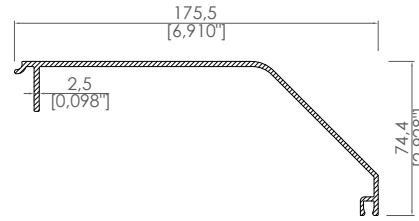

Motor Kutusu Kapağı  
Motor Box Cover

Ürün Kodu / Product Code	3182
Kalınlık / Thickness	2,5 mm
Ağırlık / Weight	1,550 kg/m 3,417 lb/m

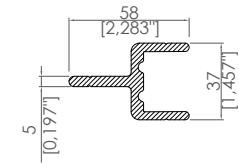

Makara Bağlantı Profili  
Pulley Connection Profile

Ürün Kodu / Product Code	3567
Kalınlık / Thickness	5 mm
Ağırlık / Weight	1,390 kg/m 3,0644 lb/m

**BAHÇE ÇİTİ VE  
RÜZGAR KIRICI SİSTEMLERİ**  
GARDEN FENCE AND  
WINDBRAKER SYSTEMS

**Bahçe Çiti Profilleri**  
Garden Fence Profiles



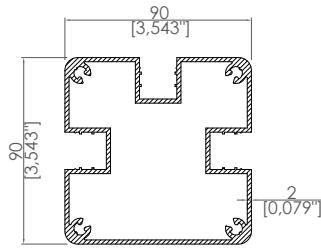

Standart Dikme Profili  
Standart Pillar Profile

Ürün Kodu / Product Code	8135
Kalınlık / Thickness	2 mm
Ağırlık / Weight	3,122 kg/m 6,683 lb/m

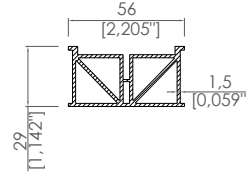

56x29 Deck Destek Profili  
56x29 Deck Support Profile

Ürün Kodu / Product Code	8131
Kalınlık / Thickness	1,5 mm
Ağırlık / Weight	1,110 kg/m 2,447 lb/m

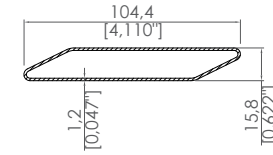

104,4x15,8 Panel Profili  
104,4x15,8 Panel Profile

Ürün Kodu / Product Code	3321
Kalınlık / Thickness	1,2 mm
Ağırlık / Weight	0,705 kg/m 1,5543 lb/m

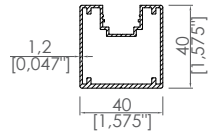

Panel Çerçeve Profili  
Panel Frame Profile

Ürün Kodu / Product Code	8281
Kalınlık / Thickness	1,2 mm
Ağırlık / Weight	0,737 kg/m 1,6248 lb/m

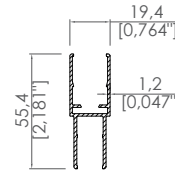

Cam Panel Profili  
Glass Panel Profile

Ürün Kodu / Product Code	8181
Kalınlık / Thickness	1,2 mm
Ağırlık / Weight	0,483 kg/m 1,0648 lb/m

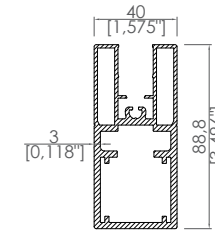

Kapı Çerçeve Profili  
Door Frame Profile

Ürün Kodu / Product Code	8153
Kalınlık / Thickness	1,6 mm
Ağırlık / Weight	2,423 kg/m 5,342 lb/m

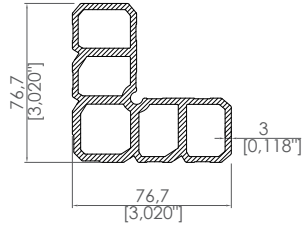

**Cam Panel Köşe Takoza**  
Glass Panel Corner Block Profile

Ürün Kodu / Product Code	2972
Kalınlık / Thickness	1,1 mm
Ağırlık / Weight	3,440 kg/m 7,584 lb/m

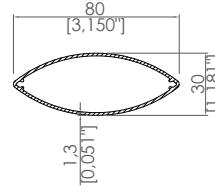

**80x30 Güneş Kırıcı Profili**  
80x30 Sun Breaker Profile

Ürün Kodu / Product Code	2596
Kalınlık / Thickness	1,3 mm
Ağırlık / Weight	0,626 kg/m 1,38 lb/m

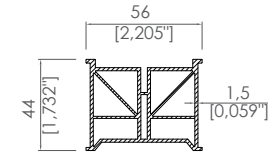

**56x44 Deck Destek Profili**  
56x44 Deck Support Profile

Ürün Kodu / Product Code	8130
Kalınlık / Thickness	1,5 mm
Ağırlık / Weight	1,377 kg/m 3,036 lb/m

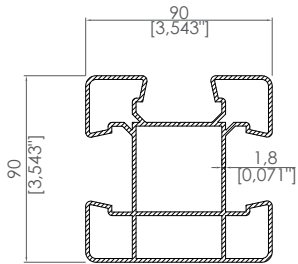

**Dikme Profili**  
Pillar Profile

Ürün Kodu / Product Code	3528
Kalınlık / Thickness	1,8 mm
Ağırlık / Weight	2,992 kg/m 6,596 lb/m

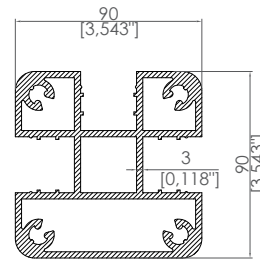

**Dikme Profili**  
Pillar Profile

Ürün Kodu / Product Code	3421
Kalınlık / Thickness	3 mm
Ağırlık / Weight	2,512 kg/m 5,538 lb/m

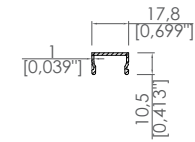

**Dikme Kapak Profili**  
Pillar Cover Profile

Ürün Kodu / Product Code	3406
Kalınlık / Thickness	1 mm
Ağırlık / Weight	0,117 kg/m 0,3902 lb/m



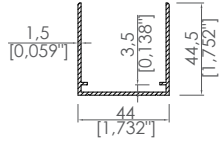

Panel Dikme Bağlantı Profili  
Panel - Pillar Connection

Ürün Kodu / Product Code	3726
Kalınlık / Thickness	1,5 mm
Ağırlık / Weight	0,545 kg/m 1,2015 lb/m

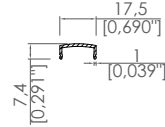

Standart Dikme Kapak Profili  
Standart Pillar Cover Profile

Ürün Kodu / Product Code	8136
Kalınlık / Thickness	1 mm
Ağırlık / Weight	0,090 kg/m 0,1984 lb/m

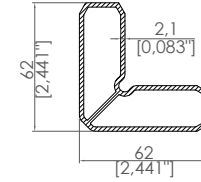

Kasa Köşe Takoğu Profili  
Frame Corner Block Profile

Ürün Kodu / Product Code	2971
Kalınlık / Thickness	2,1 mm
Ağırlık / Weight	1,442 kg/m 3,179 lb/m

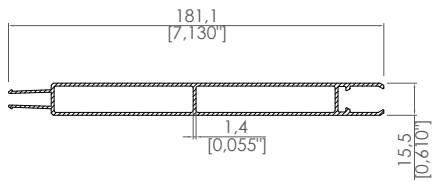

180x15 Panel Profili  
180x15 Panel Profile

Ürün Kodu / Product Code	8138
Kalınlık / Thickness	1,4 mm
Ağırlık / Weight	1,520 kg/m 3,351 lb/m

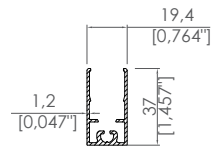

Panel Üst Profili  
Panel Top Profile

Ürün Kodu / Product Code	8137
Kalınlık / Thickness	1,2 mm
Ağırlık / Weight	0,406 kg/m 0,895 lb/m

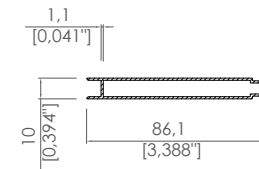

86x10 Panel Profili  
86x10 Panel Profile

Ürün Kodu / Product Code	2399
Kalınlık / Thickness	1,1 mm
Ağırlık / Weight	0,537 kg/m 1,184 lb/m

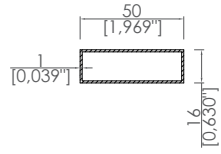
Kutu Profili  
Box Profile

Ürün Kodu / Product Code	2609
Kalınlık / Thickness	1 mm
Ağırlık / Weight	0,350 kg/m 0,7716 lb/m

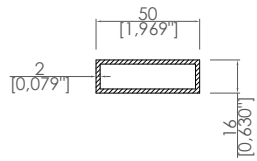
Kutu Profili  
Box Profile

Ürün Kodu / Product Code	3704
Kalınlık / Thickness	2 mm
Ağırlık / Weight	0,672 kg/m 1,4815 lb/m



**BAHÇE ÇİTİ VE  
RÜZGAR KIRICI SİSTEMLERİ**  
GARDEN FENCE AND  
WINDBRAKER SYSTEMS

**Rüzgar Kırıcı Profilleri**  
Windbraker Profiles



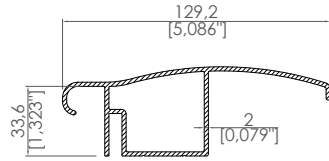

**Küpeşte Profili**  
Handrail Profile

Ürün Kodu / Product Code	3040
Kalınlık / Thickness	2 mm
Ağırlık / Weight	1,572 kg/m 3,466 lb/m

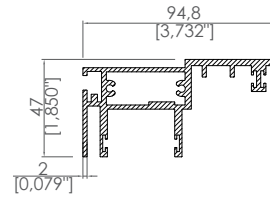

**Sabit Panel Dikme Profili**  
Fixed Panel Pillar Profile

Ürün Kodu / Product Code	3039
Kalınlık / Thickness	2 mm
Ağırlık / Weight	2,110 kg/m 4,652 lb/m

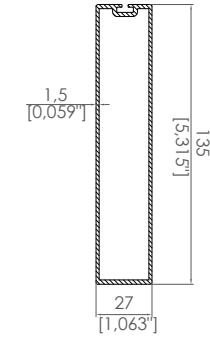

**Ağırlıklı Profili**  
Weight Profile

Ürün Kodu / Product Code	3492
Kalınlık / Thickness	1,5 mm
Ağırlık / Weight	1,415 kg/m 3,1195 lb/m

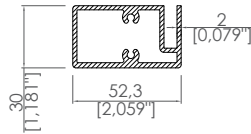

**Cam Panel Alt Profili**  
Glass Panel Bottom Profile

Ürün Kodu / Product Code	3042
Kalınlık / Thickness	2 mm
Ağırlık / Weight	1,210 kg/m 2,6676 lb/m

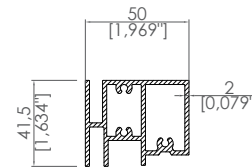

**Hareketli Cam Yan Profil**  
Movable Glass Side Profile

Ürün Kodu / Product Code	3041
Kalınlık / Thickness	2 mm
Ağırlık / Weight	1,450 kg/m 3,197 lb/m

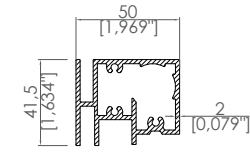

**Pistonlu Dikme Profili**  
Pillar Profile For Piston

Ürün Kodu / Product Code	3043
Kalınlık / Thickness	2 mm
Ağırlık / Weight	1,390 kg/m 3,0644 lb/m

# **BILGE**

PERGOLA & OUTDOOR LIVING SYSTEMS







**BILGE**  
PERGOLA & OUTDOOR LIVING SYSTEMS

**Turkey**

Mecidiye Mah. Ağrı Cad.  
No: 120 Sultanbeyli / Istanbul

T. +90 543 184 78 24  
T. +90 535 108 77 94

**Germany**

Ostendstr. 17, 64319  
Pfungstadt, Frankfurt

T. +49 163 209 7911

**UK**

293 Northfield Avenue,  
Ealing W5 4XB, London

T. +44 7789 994837

**Switzerland**

Hofackerstrasse 13  
CH-8543 Gundetswil

T. +41 79 133 22 88

**Spain**

C/ Nuestra Señora de  
Gracia 26 29602, Marbella

T. +34 610 07 60 80